



SPHERICAL ROLLER BEARINGS

An unrivalled extensive product range!

NTN® **SNR**®

www.ntn-snr.com



With You



NTN-SNR THE STRENGTH OF A GROUP

NTN Corporation, a global leader in bearings, specializes in designing, developing and producing spherical roller bearings.

With NTN-SNR BEARINGS, benefit from this know-how near you with:

- An extensive range of spherical roller bearings
- The constant pursuit for excellence, culminating in high levels of performance and exceptional quality
- Extended service life and unfailing reliability, as recognised by thousands of users around the world

Globally, NTN Corporation is an expert in product life cycle management, and is typified by the accessibility and commitment of its teams.

[NTN-SNR ACCOMPANIES YOU ON THE ROAD TO RELIABILITY AND PERFORMANCE](#)

CHARACTERISTICS OF THE RANGE

Principle of spherical roller bearings	06
ULTAGE quality	06
Controlled manufacturing	08
Sectors of activity and applications	10
Designations	11
Types of design	12
Cages	14
Internal radial clearance and tolerances	16
Dedicated products	
• EF800 series for high-vibration applications	17
• Sealed products with elastomer seals	19
• All-in-one bearing kits	20
• KIZEI®: the first spherical roller bearing with metal shields	21
• Products with solid lubrication	22

TECHNICAL INFORMATION

Nominal service life	26
Adjusted nominal service life	27
Method for determining a_{ISO} (ISO 281)	28
Determining the minimum viscosity	30
Speeds	30
Lubrication	33
Adjustments	38

PRACTICAL INFORMATION

Mounting and removal	42
Fitting & removal tools	48
Services	49

LIST OF REFERENCES

Prefixes/suffixes	53
Spherical roller bearing references	54
Mounting / withdrawal sleeves	70
Associated plummer blocks	74
Lubrication products	76



ULTAGI



CHARACTERISTICS OF THE RANGE

Principle of spherical roller bearings	06
ULTAGE quality	06
Controlled manufacturing	08
Sectors of activity and applications	10
Designations	11
Types of design	12
Cages	14
Internal radial clearance and tolerances	16
Dedicated products	
• EF800 series for high-vibration applications	17
• Sealed products with elastomer seals	19
• All-in-one bearing kits	20
• KIZEI®: the first spherical roller bearing with metal shields	21
• Products with solid lubrication	22



CHARACTERISTICS OF THE RANGE

PRINCIPLE OF SPHERICAL ROLLER BEARINGS

Spherical roller bearings are engineered to offer excellent resistance to high temperatures and loads, meaning that they are capable of withstanding the harshest applications. They are a popular choice for absorbing misalignments, impacts and vibrations, as well as operating in polluted environments.

Misalignment

The design of the spherical roller bearings allows for misalignment between the outer ring and the inner ring with no loss of bearing performance.

Under normal operating conditions, i.e. where the C/P ratio (dynamic bearing load vs. actual load applied) is greater than 10, the permissible angle of tilt is 0.5°.

This angle of tilt is permissible in cases where the misalignment of the inner ring is constant with respect to the outer ring and in the case of a rotating inner ring.

This value depends on the parts surrounding the bearing or on the type of external seal used. In the case of a rotating outer ring or variable misalignment, the permissible angle of tilt is reduced.

In the case of low loads, the angle of tilt may reach 2°.

For these particular cases, please contact your NTN-SNR representative.

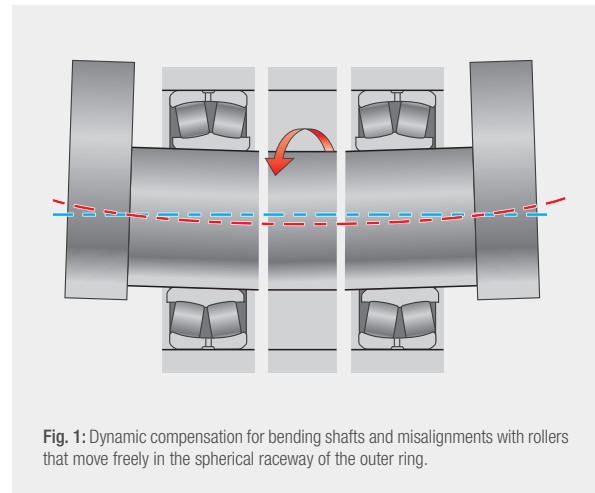

Fig. 1: Dynamic compensation for bending shafts and misalignments with rollers that move freely in the spherical raceway of the outer ring.

ULTAGE QUALITY

Maintenance operations due to a fault in a component as simple as a bearing can run into hundreds of thousands of euros depending on the application (unavailability of the user's production tools, repair times and employee downtime due to the repairs).

To raise the reliability bar on your equipment, the NTN Group has developed the ULTAGE quality hallmark for its spherical roller bearings. It combines the use of superior quality materials with an enhanced design and precision manufacturing process.



ULTAGE™

ULTAGE, the generation of NTN high-performance bearings delivering:

- Unrivalled service life
- Higher speed limits
- Maximised load capacities

i Bearings designed according to **ULTAGE** rules can be identified with the **suffix E**.

ULTAGE FEATURES

- Superior grade steel
- Improved roller size
- Enhanced surface finishes
- Cage made from high-performance solid brass or drawn steel without a central guide ring
- Specific heat treatment processes

BENEFITS

- Service life doubled with increased load capacities
- Greater rigidity and stability
- Reduced in-service temperatures with improved lubricant circulation within the bearing
- Dimensional stability up to 200°C without impairing the bearing's mechanical properties
- Speed limits 20% higher than conventional designs due to the excellent surface properties



"ULTAGE: less downtime, more profit"

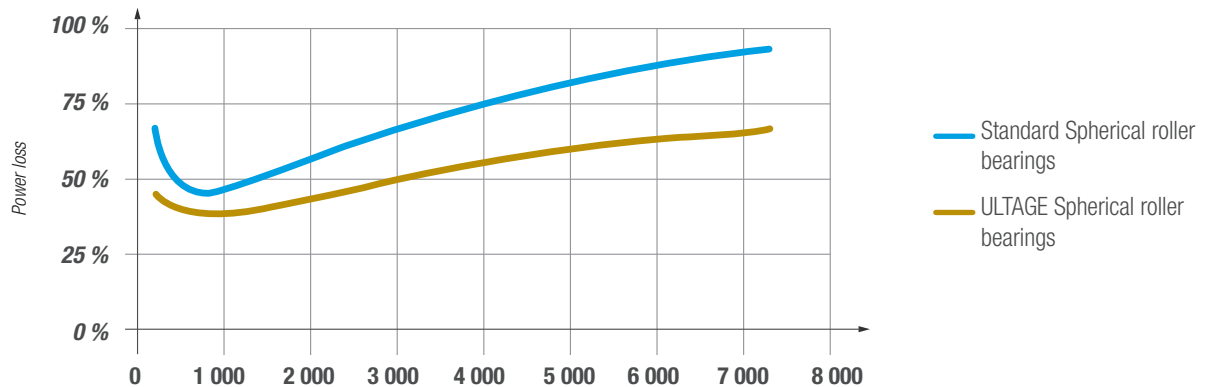

Fig. 2: Reduced power dissipation vs speed.

CONTROLLED MANUFACTURING

AN ALL-INTERNAL IRONCLAD PROCESS

Our entire range of spherical roller bearings is developed and manufactured internally in our Japanese and Italian factories.

The NTN Group is strongly committed to keeping its production processes in-house as a sign of its superlative quality and expertise, especially since its bearings are widely used in critical and costly applications. This strategy ensures that the Group exercises complete control over its range of spherical roller bearings, from product design through to marketing.

The NTN Group has spearheaded a high-performance quality assurance system for its production processes, supported by self-inspections and continuous oversight. This system assures the highest product quality over time by controlling every component of the process (means, methods, manpower, environment and materials).

Thanks to the continuous improvement approach applied to its production facilities, and its quality assurance system, the NTN Group is able to guarantee bearings with ever more precise surfaces for enhanced performance, reduced friction during operation and, consequently, improved lubrication efficiency.

For several years, NTN-SNR has integrated an environmental approach into its manufacturing processes. Accordingly, numerous initiatives have been undertaken on our production sites:

- Controlled use of the water used for cooling the production units
- Recycling of cutting oils
- Continuous monitoring of CO₂ emissions from the boilers in the thermal power plants

QUALITY: A SHARED VISION

NTN-SNR is committed to the quality of its products. All our bearings comply strictly with the most rigorous of technical requirements. The quality process is closely controlled at each stage:

- Quality of design
- Quality of product development
- Quality of production
- Quality of marketing
- Quality of services

So that you can be sure of the authenticity of our products, we have developed a label featuring a hologram that is easily identifiable and difficult to fake.

"A fully guaranteed NTN-SNR product meeting the Group's quality requirements"





SPHERICAL ROLLER BEARING

An unrivalled extensive product range!

NTN 

www.ntn-snr.com



With You

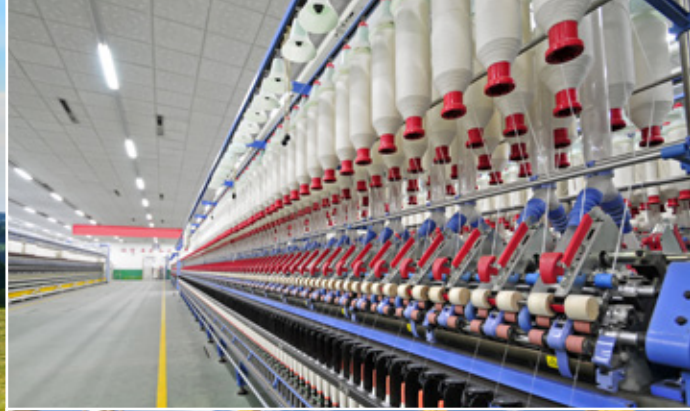

SECTORS OF ACTIVITY AND APPLICATIONS

NTN-SNR possesses one of the widest ranges of spherical roller bearings offering high-end load capacity and speed performance. Expertise in product design and complete control over the production process guarantee the best results for the most demanding applications.



DESIGNATIONS

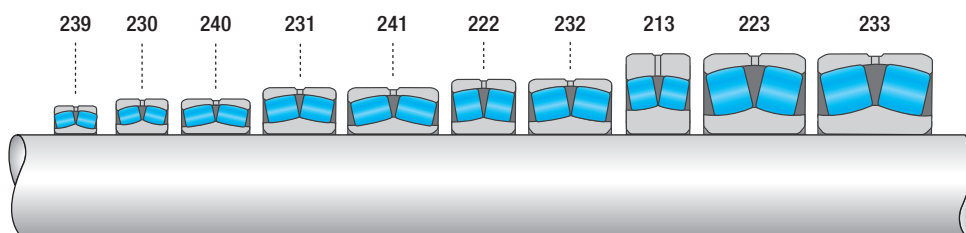
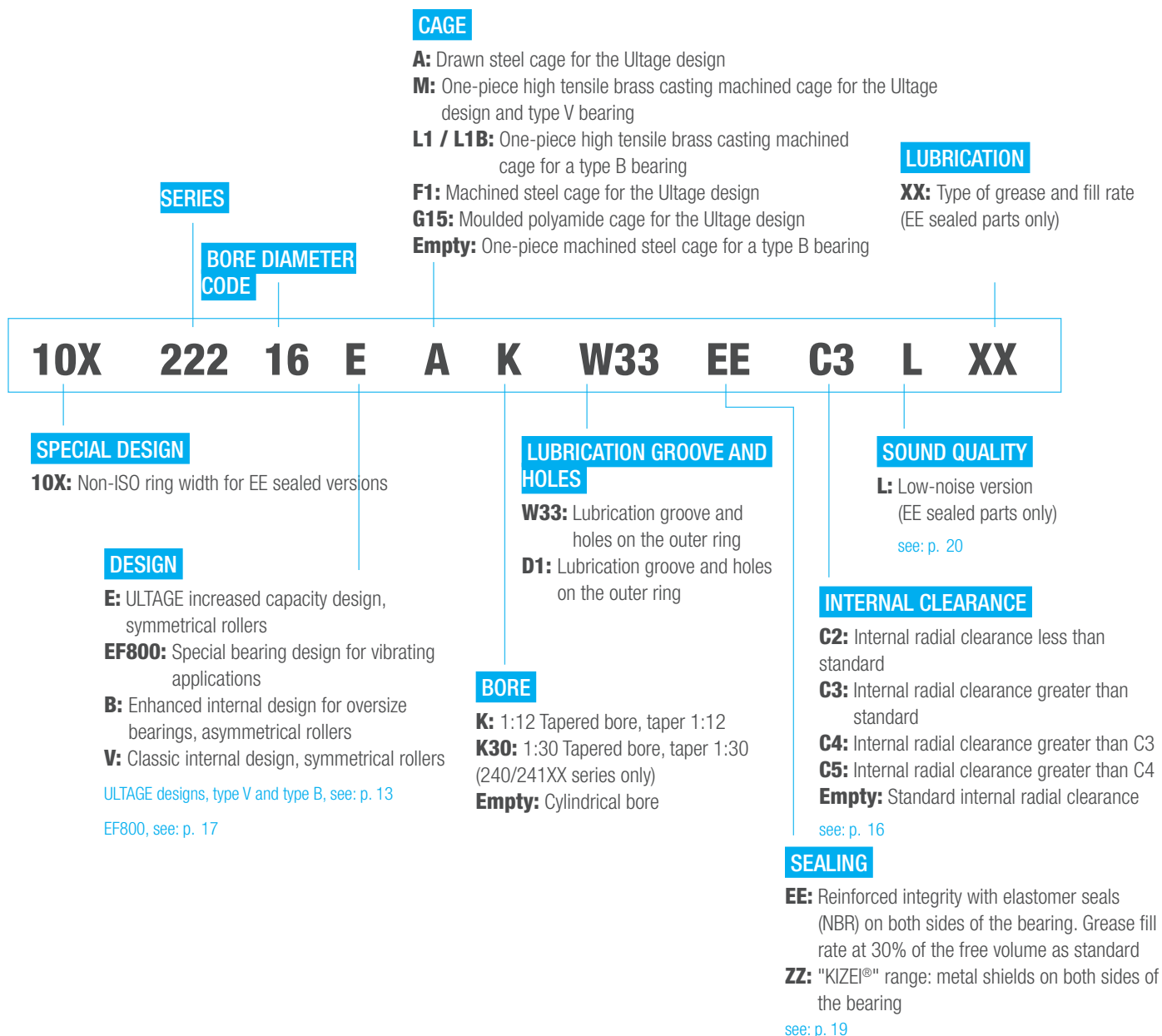

Fig. 3: Series of spherical roller bearings available from NTN-SNR

NTN-SNR proposes a full range of spherical roller bearings with cylindrical and tapered bores from 25 to 1400 mm. These bearings are available in several series designed to cater to the broadest spectrum of usages depending on your requirements in terms of loads, speeds and dimensions.

Most spherical roller bearings are proposed with the Ultage design (type E). Some products are available with a conventional design (type V) or asymmetric design specific to oversize versions (type B).

CODE SYSTEM



TYPES OF DESIGN

ULTAGE DESIGN: TYPE E

- Symmetrical rollers
- No central rib for optimal load capacity and optimum lubricant flow in the bearing
- Stabilisation of the steel for use at temperatures of up to +200°C
- Optimised internal geometry to minimise friction and heat build-up
- Cage made from drawn steel (EA), fibre glass reinforced polyamide (EG15) or machined solid brass (EM) for the harshest applications
- Lubrication groove and holes on the outer ring (W33 or D1)



Do not use a product with a fibre glass reinforced polyamide cage over 150°C

AN IMPROVED DESIGN FOR BETTER LUBRICATION

55% of bearing faults are due to lubrication defects, meaning that lubrication plays a major role in ensuring peak performance.

Just like the design, geometry and surface finish of the different bearing components, the viscosity of the lubricant is vitally important for increasing the bearing's operation and service life. The Ultage design represents the enhanced combination of all these factors.

- **No central shoulder section:** the available volume is higher so that the lubricant can flow more freely, meaning that the different parts of the bearing are constantly lubricated. This design drastically reduces the risk of overheating.
- **Wider lubrication holes and grooves:** this design feature simplifies bearing maintenance and relubrication. The number of lubrication holes on the outer ring may be 3, 4 or 8 depending on the bearing brand and size (information specified in the product tables on page 54).
- **Improved cage materials and design:** the cage is a risk-prone part of the bearing and is often the cause of faults. Special attention has been taken over the cage design (see p.14).

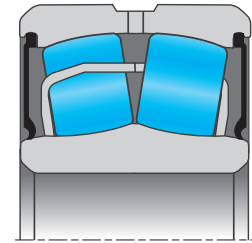

Fig. 4: Cross-sectional diagram of the Ultage design with a drawn steel cage (EA)

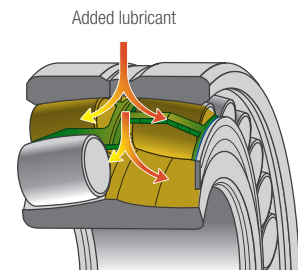

Fig. 5: The lubricant flows more freely inside the bearing

Number of lubrication holes

Outer diameter of the bearing Ø D mm		Number of lubrication holes		
		D1	W33	B
≥	≤	k	k	k
-	320	4	3-4*	
320	420	8	3-8*	
420	1000	8	8	8
1000	-	12		12

Note: For the width of the fill groove "**b**" and the diameter of the fill hole "**k**", refer to the table entitled "**spherical roller bearing references**" on pages 56 to 73 of the catalogue.

*3 or 4 / 3 or 8 lubrication holes depending on the model

Specific ULTAGE design for oversize bearings

For bearings with a bore diameter of 420 mm and above, a guide ring is added between the cage and the inner ring of the bearing. This specific design guarantees improved long-term strength for oversize bearings.

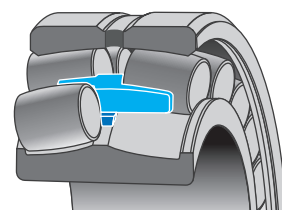

Fig. 6: Ultage design for oversize bearings

TYPE B DESIGN

- Design used for oversize bearings
- Asymmetrical rollers
- Shoulder section fixed to the centre of the inner ring
- Stabilisation of the steel for use at temperatures of up to +200°C
- Machined steel or brass cage
- Lubrication groove and holes on the outer ring (not indicated by a suffix)

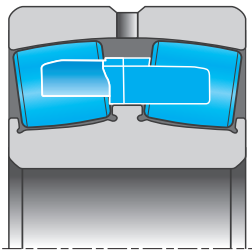

Fig. 7: Cross-sectional diagram of a type B bearing

TYPE V DESIGN

- Earlier generation to the Ultage design, type E
- Symmetrical rollers
- No central rib for optimal load capacity and optimum lubricant flow in the bearing
- Stabilisation of the steel for use at temperatures of up to +200°C
- Cage made from drawn steel or solid brass (M)
- Lateral retaining shoulder sections for the rollers
- No lubrication grooves or holes on the outer ring as standard

CAGES

ULTAGE EA DESIGN - DRAWN STEEL CAGE

"Minimal friction and heat build-up, increased service life and reduced maintenance costs"

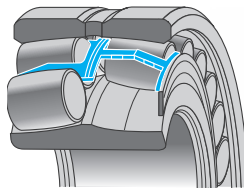

Fig. 8: Ultage design bearing with EA cage

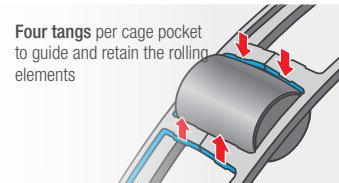

Fig. 9: Unique guidance system for perfect control

- Two steel plate window cages centred on the ground surface of the inner ring
- Precise guidance of the rollers with a unique four-tang system for perfect control of the position of the rolling elements

The steel plate cages are reinforced with a specific surface treatment process, which may either be nitriding or phosphating depending on the bearing dimensions.

Combination layer
~ 10 μm / ~ 400 HV Diffusion layer
~ 100 μm / ~ 250 HV

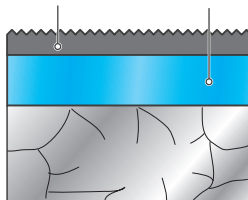

Fig. 10: Cross-sectional view of the nitriding surface treatment for a steel plate cage

CAGES WITH NITRIDING SURFACE TREATMENT

- Increased surface hardness of the cage for superior wear resistance
- Maintained resistance in the cage core to improve impact resistance
- Lower friction coefficient for greater in-service performance at high speeds
- Good corrosion resistance

Phosphate layer
~ 20 μm

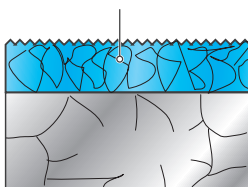

Fig. 11: Cross-sectional view of the phosphating surface treatment for a steel plate cage

CAGES WITH PHOSPHATING SURFACE TREATMENT

- Lower friction coefficient for greater in-service performance at high speeds
- Good corrosion resistance

ULTAGE DESIGN EM - HIGH TENSILE BRASS CASTING MACHINED CAGE

"Especially suited to the most demanding applications"

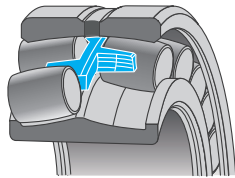

Fig. 12: Ultage design bearing with EM cage

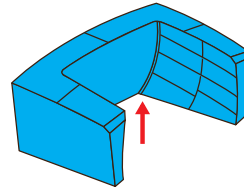

Fig. 13: Contoured pocket to guide the rolling elements

- Machined brass alloy one-piece cage centred on the rolling elements
- Simple design without a guide ring or fixed central shoulder section to avoid a cage/ring seizure in the event of thermal expansion
- Contoured profile of the cage pockets to guarantee perfect stability of the rolling elements under the harshest operating conditions
- Self-lubricating properties of the brass to reduce overheating at high speed

ULTAGE DESIGN EG15 – MOULDED POLYAMIDE CAGE (on request; contact us)

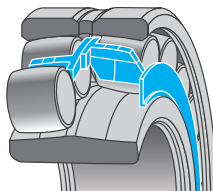

Fig. 14: Ultage design bearing with EG15 cage

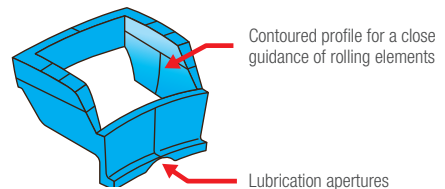

Fig. 15: Perfect guidance of the rollers with a soft material offering a low friction coefficient



Unsuitable for applications over 150°C

- 6.6 moulded polyamide cage reinforced with 25% glass fibre
- Perfect guidance of the rollers with a soft and elastic material offering a low friction coefficient
- Enhanced cage design to ensure perfect distribution of the lubricant

INTERNAL RADIAL CLEARANCE AND TOLERANCES

NTN-SNR bearings are delivered with normal precision according to ISO 492.

The internal radial clearance is defined by ISO 5753.

Radial clearance of spherical roller bearings with a cylindrical bore

Bore diameter		Internal radial clearance									
>	≤	C2		Normal		C3		C4		C5	
		min	max	min	max	min	max	min	max	min	max
mm		μm									
14	18	10	20	20	35	35	45	45	60	60	75
18	24	10	20	20	35	35	45	45	60	60	75
24	30	15	25	25	40	40	55	55	75	75	95
30	40	15	30	30	45	45	60	60	80	80	100
40	50	20	35	35	55	55	75	75	100	100	125
50	65	20	40	40	65	65	90	90	120	120	150
65	80	30	50	50	80	80	110	110	145	145	180
80	100	35	60	60	100	100	135	135	180	180	225
100	120	40	75	75	120	120	160	160	210	210	260
120	140	50	95	95	145	145	190	190	240	240	300
140	160	60	110	110	170	170	220	220	280	280	350
160	180	65	120	120	180	180	240	240	310	310	390
180	200	70	130	130	200	200	260	260	340	340	430
200	225	80	140	140	220	220	290	290	380	380	470
225	250	90	150	150	240	240	320	320	420	420	520
250	280	100	170	170	260	260	350	350	460	460	570
280	315	110	190	190	280	280	370	370	500	500	630
315	355	120	200	200	310	310	410	410	550	550	690
355	400	130	220	220	340	340	450	450	600	600	750
400	450	140	240	240	370	370	500	500	660	660	820
450	500	140	260	260	410	410	550	550	720	720	900
500	560	150	280	280	440	440	600	600	780	780	1,000
560	630	170	310	310	480	480	650	650	850	850	1,100
630	710	190	350	350	530	530	700	700	920	920	1,190
710	800	210	390	390	580	580	770	770	1,010	1,010	1,300
800	900	230	430	430	650	650	860	860	1,120	1,120	1,440
900	1,000	260	450	450	710	710	930	930	1,220	1,220	1,570
1,000	1,120	290	530	530	780	780	1,020	1,020	1,330	1,330	1,720
1,120	1,250	320	580	580	860	860	1,120	1,120	1,450	1,450	1,870
1,250	1,400	350	640	640	950	950	1,240	1,240	1,620	1,620	2,050
1,400	1,600	400	720	720	1,060	1,060	1,380	1,380	1,800	1,800	2,300
1,600	1,800	450	810	810	1,180	1,180	1,550	1,550	2,000	2,000	2,550

Radial clearance for spherical roller bearings with a tapered bore

Bore diameter		Internal radial clearance									
>	≤	C2		Normal		C3		C4		C5	
		min	max	min	max	min	max	min	max	min	max
mm		μm									
18	24	15	25	25	35	35	45	45	60	60	75
24	30	20	30	30	40	40	55	55	75	75	95
30	40	25	35	35	50	50	65	65	85	85	105
40	50	30	45	45	60	60	80	80	100	100	130
50	65	40	55	55	75	75	95	95	120	120	160
65	80	50	70	70	95	95	120	120	150	150	200
80	100	55	80	80	110	110	140	140	180	180	230
100	120	65	100	100	135	135	170	170	220	220	280
120	140	80	120	120	160	160	200	200	260	260	330
140	160	90	130	130	180	180	230	230	300	300	380
160	180	100	140	140	200	200	260	260	340	340	430
180	200	110	160	160	220	220	290	290	370	370	470
200	225	120	180	180	250	250	320	320	410	410	520
225	250	140	200	200	270	270	350	350	450	450	570
250	280	150	220	220	300	300	390	390	490	490	620
280	315	170	240	240	330	330	430	430	540	540	680
315	355	190	270	270	360	360	470	470	590	590	740
355	400	210	300	300	400	400	520	520	650	650	820
400	450	230	330	330	440	440	570	570	720	720	910
450	500	260	370	370	490	490	630	630	790	790	1,000
500	560	290	410	410	540	540	680	680	870	870	1,100
560	630	320	460	460	600	600	760	760	980	980	1,230
630	710	350	510	510	670	670	850	850	1,090	1,090	1,360
710	800	390	570	570	750	750	960	960	1,220	1,220	1,500
800	900	440	640	640	840	840	1,070	1,070	1,370	1,370	1,600
900	1,000	490	710	710	930	930	1,190	1,190	1,520	1,520	1,860
1,000	1,120	530	770	770	1,030	1,030	1,300	1,300	1,670	1,670	2,050
1,120	1,250	570	830	830	1,120	1,120	1,420	1,420	1,830	1,830	2,250
1,250	1,400	620	910	910	1,230	1,230	1,560	1,560	2,000	2,000	2,450
1,400	1,600	630	1,000	1,000	1,350	1,350	1,720	1,720	2,200	2,200	2,700
1,600	1,800	750	1,110	1,110	1,500	1,500	1,920	1,920	2,400	2,400	2,950

DEDICATED PRODUCTS

EF800 SERIES FOR HIGH-VIBRATION APPLICATIONS

For high-vibration applications (screens, crushers and grinders), the generally recommended internal clearance is C4. In order to avoid any risk of preload on the bearings, linked to adjustment defects or deformation of the shaft or housing seating surfaces, NTN-SNR proposes a special radial clearance range in the C4 group, reduced to 2/3 of the tolerance. This new range facilitates the achievement and control of the final radial clearance after assembly and takes account of the specific operating conditions for these vibrating materials.



ULTAGE™



Products corresponding to the specification can be identified by the suffix **EF800**.

CHARACTERISTICS

- ULTAGE bearing with symmetrical rollers and machined brass alloy one-piece cage centred on the rolling elements
- Available in a range of bore diameters from 40 to 200 mm
- Cylindrical and tapered bores available
- No floating guide ring or fixed central shoulder section to avoid any risk of a cage/ring seizure in the event of thermal expansion
- Special tolerances for the outer diameter and bore
- Outer diameter: the tolerances of the EF800 specification guarantee the fixed adjusting of the outer ring in its housing for a type P6 fit
- Cylindrical bore: the reduced tolerances defined by the EF800 specification guarantee a sliding adjusting of the inner ring over the shaft produced with a type g6 or f6 tolerance
- Tapered bore: the reduced tolerances enabling limitation of the axial displacement of the inner ring when setting the clearance during assembly, thereby facilitating the assembly operations

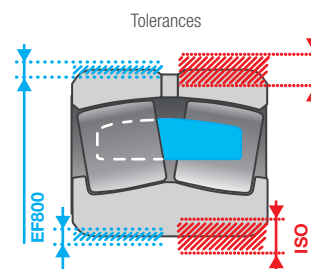

Fig. 16: Special tolerances for the outer diameter and bore

BENEFITS

- Increased service life
- Wider maintenance intervals
- Greater operational profitability

Note: In certain cases, applications may necessitate the use of a clearance other than group C4. Upon request, we can deliver bearings in groups C3, EF801 series or CN, EF802 series. For the EF801 and EF802 series, just like the EF800 series, the clearance range is reduced to 2/3 of the tolerance.

Clearance	22220		Clearance in microns											
	Minimum	Maximum	130	135	140	145	150	155	160	165	170	175	180	185
C4	135	180												
Clearance EF800	150	180												

EF800 series = C4 with reduced tolerance

E.g. EF800 clearance value compared to the clearance value of group C4

EF800, EF801, EF802 DIAMETER TOLERANCES

	Nominal bore "mm"		Differences in microns "µm"			
	>	≤	Cylindrical bore		Tapered bore	
	Inner ring	30	50	0	-7	25
	50	80	0	-9	30	0
	80	120	0	-12	35	0
	120	180	0	-15	40	0
	180	250	0	-18	46	0

	Nominal outer diameter "mm"		Differences in microns "µm"	
	>	≤	Cylindrical bore	
	Outer ring	80	120	-5
	120	150	-5	-13
	150	180	-5	-18
	180	250	-10	-23
	250	315	-10	-23
	315	400	-13	-28
	400	500	-13	-30
	500	630	-15	-35

EF800, EF801, EF802 INTERNAL RADIAL CLEARANCE

Cylindrical bores

Nominal bore "mm"		Clearances in microns "µm"					
>	≤	Group C4 = EF800		Group C3 = EF801		Group CN = EF802	
30	40	65	80	50	60	35	45
40	50	85	100	60	75	40	55
50	65	100	120	75	90	50	65
65	80	120	145	90	110	60	80
80	100	150	180	110	135	75	100
100	120	180	210	135	160	90	120
120	140	205	240	160	190	110	145
140	160	240	280	190	220	130	170
160	180	260	310	200	240	140	180
180	200	285	340	220	260	155	200
200	225	320	380	245	290	165	220
225	250	355	420	265	320	180	240
250	280	385	460	290	350	200	260

Tapered bores (1/12)

Nominal bore "mm"		Clearances in microns "µm"					
>	≤	Group C4 = EF800		Group C3 = EF801		Group CN = EF802	
30	40	70	85	55	65	40	50
40	50	85	100	65	80	50	60
50	65	105	120	80	95	60	75
65	80	130	150	100	120	80	95
80	100	155	180	120	140	90	110
100	120	185	220	145	170	110	135
120	140	220	260	175	200	135	160
140	160	255	300	195	230	145	180
160	180	285	340	220	260	160	200
180	200	315	370	245	290	180	220
200	225	350	410	275	320	205	250
225	250	385	450	295	350	225	270
250	280	425	490	330	390	245	300

SEALED BEARINGS WITH ELASTOMER SEALS

To prevent ingress and contamination if bearings are used in hostile environments, such as outdoors or in dusty conditions, you are advised to use sealed bearings.

These compact solutions offer a constant hermetic seal even when there is bending of the shaft (up to 0.5° maximum).

CHARACTERISTICS

- Identical internal design to the open bearings with the ULTAGE EA design
- Non-ISO width with a minimal increase in order to integrate seals (10X prefix)
- Specially designed NBR seal to guarantee impermeability by means of constant contact pressure of the lip, even in the event of misalignment
- Pre-filled bearing with a quantity and quality of lubricant suited to high loads; no relubrication is required for applications below 70°C
- Operation up to +120°C; for higher temperatures, the materials of the seals and the quality of the lubricant need to be adapted accordingly



"Our seals with their superior geometric design are tested in our laboratories under the most extreme conditions to guarantee their reliability and their performance for your applications"

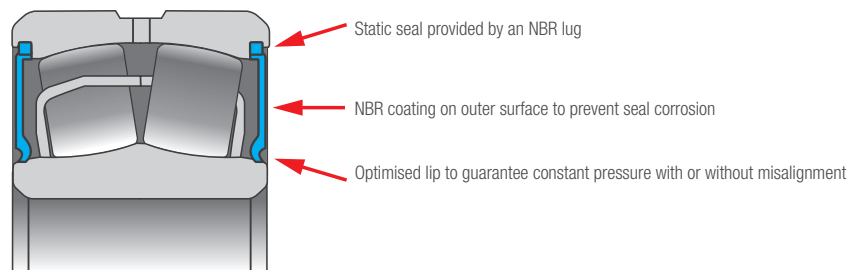

Fig. 17: Ultage design sealed bearing

BENEFITS

- Increased service life
- Wider maintenance intervals
- Greater operational profitability
- Protection of the environment

EE sealed spherical roller bearings are frequently used in such applications as steel industry conveyors, mines, power transmission systems for elevators and printing machinery.

Note: During mounting, feeler gauges cannot be used to check the internal clearance of sealed bearings due to the seals. All the specific mounting recommendations and advice for checking the clearance for this type of bearing are explained on pages 45-46.

SPECIAL CASE OF LOW-NOISE APPLICATIONS

Some applications, such as the power transmission system for elevators, are particularly demanding in terms of the noise made by the bearings. Therefore, NTN-SNR offers sealed spherical roller bearings with low vibration levels, which are identified by the suffix L and which are available on request. Their improved geometric and functional characteristics significantly reduce the amount of noise generated.

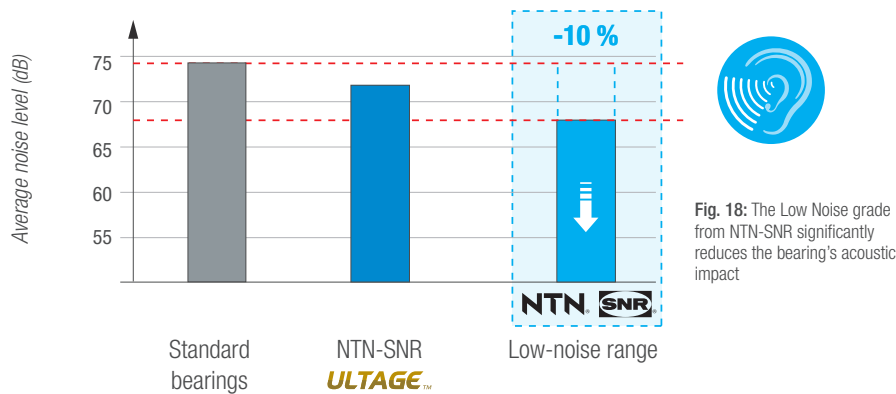

Fig. 18: The Low Noise grade from NTN-SNR significantly reduces the bearing's acoustic impact

ALL-IN-ONE BEARING KITS: AN INNOVATIVE SOLUTION TO ASSIST YOU

To bring greater simplicity to your partial and full maintenance operations, NTN-SNR offers a wide array of ready-to-use kits containing spherical roller bearings and the associated products required for their operation, all of which in a single container. Several options are available to accurately satisfy your specific needs.

CHARACTERISTICS

NTN-SNR offers three types of kit:

- **One kit for partial maintenance**, comprising an ULTAGE sealed spherical roller bearing, a special sealed mounting sleeve and two special sealed locating rings
- **One kit for full maintenance**, comprising an ULTAGE sealed spherical roller bearing, an SNC split plummer block, a special sealed mounting sleeve, two special sealed locating rings, two sets of NBR seals and a plug
- **One kit for full maintenance**, comprising an ULTAGE open spherical roller bearing, an SNC split plummer block, a mounting sleeve, two locating rings, two sets of NBR seals, a plug and a DRIVE BOOSTER automatic lubrication system
- All kits contain technical instructions with advice on how to adjust the internal clearance through axial displacement and relubrication instructions
- Kits are available for shaft diameters between 35 and 90 mm
- Each kit reference is available with a standard clearance (CN) or increased clearance (C3)

"The premium grade of our spherical roller bearing solutions with split plummer blocks can bring ultimate reliability to your facilities."



BENEFITS

- Streamlined inventory: only one reference to order and store
- Limited risk of errors and omissions: all specific components for each bearing are included in the kit
- Flexible use: each kit can be used for fixed or floating bearing units

KIZEI®: THE FIRST SPHERICAL ROLLER BEARING WITH METAL SHIELDS

NTN-SNR's R&D department has pioneered an unprecedented solution to increase the service life of your spherical roller bearings.

CHARACTERISTICS

- ULTAGE load capacities and speed
- **ISO dimensions:** 100% interchangeable with an open spherical roller bearing



ISO NON-ISO
KIZEI® and open designs Design with seals

Fig. 19: The KIZEI® bearing is available in ISO widths, just like an open spherical roller bearing

- Premium quality nitrided steel plate cage and shields for maximum impact strength and superior corrosion resistance
- Extensive range of operating temperatures from -40°C to +200°C
- **Kizei® is supplied ungreased:** the initial lubrication process is similar to an open spherical roller bearing; 30% of the free volume must be filled with the appropriate grease
- The bearing can be lubricated while in service via the dedicated holes and grooves on the outer ring
- **Internal inspection possible** for easier maintenance
- **Easy mounting process:** no special tools are required, and the clearance can be checked after mounting

BENEFITS

- Improved production performance with the longer service life
- Reduced maintenance costs
- Easy to use

ULTAGE™

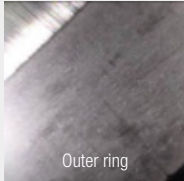
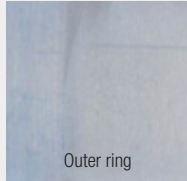

"KIZEI®: the ideal alternative for dusty environments and reducing maintenance costs"

INITIAL BEARING	[KIZEI]®												
1,100 hours in service	2,200 hours in service												
													
<p>Less deterioration to the bearing after a service life lasting twice as long</p>													
	<table border="1"> <thead> <tr> <th></th> <th>Open spherical roller bearing</th> <th>[KIZEI]</th> </tr> </thead> <tbody> <tr> <td>Life duration</td> <td>1 month</td> <td>3 month</td> </tr> <tr> <td>Production downtime</td> <td>12 times/year</td> <td>4 times/year</td> </tr> <tr> <td>Maintenance costs</td> <td>100</td> <td>30</td> </tr> </tbody> </table>		Open spherical roller bearing	[KIZEI]	Life duration	1 month	3 month	Production downtime	12 times/year	4 times/year	Maintenance costs	100	30
	Open spherical roller bearing	[KIZEI]											
Life duration	1 month	3 month											
Production downtime	12 times/year	4 times/year											
Maintenance costs	100	30											
<p>Maintenance costs can be reduced by a factor of 3</p>													

NTN-SNR SPHERICAL ROLLER BEARINGS: THE WIDEST RANGE ON THE MARKET

	OPEN	[KIZEI]	SEALED
Dimensions	ISO	ISO	Special
Protection	0	+*	++
Grease retention	0	+	++
Temperature range	-40°C to +200°C	-40°C to +200°C	-10°C to +120°C
Limiting speed	++	++	+
Load capacity	Ultage	Ultage	Ultage
Clearance inspection	Yes	Yes	No
Internal control	Yes	Yes	No
Sleeve and nut	Standard	Standard	Special
Supplied already greased	No	No	Yes

*Valid against solid contamination - Not suitable for liquids

PRODUCTS WITH SOLID LUBRICATION

For highly specific operating constraints where traditional brands of grease quickly show their limitations (low-amplitude oscillations, high centrifugal forces, washing out, pollution, difficult access, etc.), NTN-SNR has developed a solid lubrication concept suited to spherical roller bearings.



CHARACTERISTICS

- Porous polymer matrix that fills the free volume of the bearing and can contain three to four times more oil than conventional grease for improved lubrication
- Suitable for speeds less than 100,000 N.Dm

In applications where the bearing is subject to centrifugal phenomena, a traditional lubricant can be ejected instantaneously from the bearing, whereas a solid lubricant allows the oil to be kept within the bearing and to operate for thousands of hours.

BENEFITS

- Longer service life since oil is constantly supplied to the bearing core
- No re-lubrication required
- Excellent resistance to centrifugal forces
- Environmental protection by reducing lubricant leaks
- Sealing effect: the solid lubricant acts as a shield against external particles

NTN-SNR is at your disposal to determine the suitability of this concept in your applications.

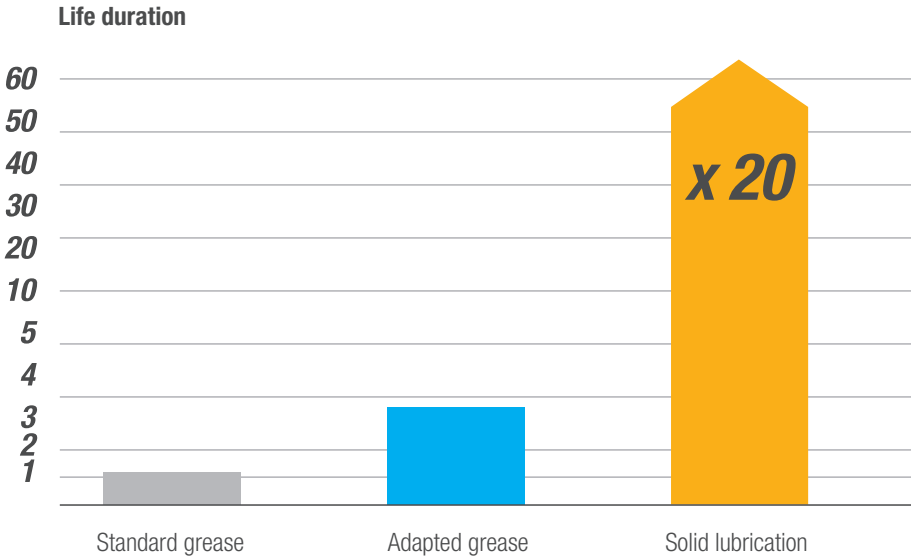

Fig. 20: Solid lubrication: a cutting-edge technology to drastically increase the service life of your bearings



ISO SPHERICAL
ROLLER BEARING
WITH SHIELDS [KIZEI][®]

KIZEI[®], armoured to face the dirt!*



www.ntn-snr.com



With You



TECHNICAL INFORMATION

Nominal service life	26
Adjusted nominal service life	27
Method for determining a_{ISO} (ISO 281)	28
Determining the minimum viscosity	30
Speeds	30
Lubrication	33
Adjustments	38

TECHNICAL INFORMATION

NOMINAL SERVICE LIFE

The nominal service life, L_{10} , recommended by ISO 281, is given by the equation $L_{10} = (C / P)^n$ where $n=10/3$ for the roller bearings. This equation is defined for a reliability level of 90% under normal operating conditions.

Nominal service life

$$L_{10} = (C/P)^n \text{ in millions of revs}$$

or

$$L_{10} = (C/P)^n \cdot 10^6 / 60N \text{ in hours}$$

C = Basic dynamic load (Newton)

P = Equivalent dynamic load (Newton)

N: Rotation speed (rpm)

Equivalent dynamic load P

$$P = F_r + Y_1 \cdot F_a \text{ where } F_a/F_r \leq e$$

$$P = 0.67F_r + Y_2 \cdot F_a \text{ where } F_a/F_r > e$$

P = Equivalent dynamic load (Newton)

F_r = dynamic radial load (Newton)

F_a = dynamic axial load (Newton)

e, Y_1 , Y_2 factors according to dimensions tables (see from page 54)

Equivalent static load P_0

$$P_0 = F_{0r} + Y_0 \cdot F_{0a}$$

P_0 = Equivalent static load (Newton)

F_{0r} = Static radial load (Newton)

F_{0a} = Static axial load (Newton)

Y_0 = Factor according to dimensions table

Safety factor

$$f_s = C_0 / P_0$$

C_0 basic static capacity defined in the dimensions tables (Newton)
(see from page 54)

Minimum basic values for the static safety coefficient f_s :

- 1.5 to 3 for severe conditions
- 1 to 1.5 for normal conditions
- 0.5 to 1 for operations with no particular noise or precision requirements

If you are looking for a bearing operating under harsh conditions, the safety coefficient f_s must be high.

Minimum radial load

In order to avoid slippage phenomena between the rolling elements and the raceways, particularly in the case of high speeds or accelerations, a minimum load must be applied to spherical roller bearings.

$$P_{rm} = 0.01C_0$$

P_{rm} = minimum radial load (Newton)

C_0 = basic static load (Newton)

Maximum axial load

Spherical roller bearings can support high axial loads.

Generally, $F_a/F_r \leq e$ can be used, however it is recommended that you do not exceed the following value $F_a/F_r = 0.3$.

In the event of high loads combined with high speeds, the rise in the bearing temperature must be taken into account.

ADJUSTED NOMINAL SERVICE LIFE

BASIC NOMINAL SERVICE LIFE

- **The basic nominal service life L₁₀** is often a satisfactory estimation of the bearing performance levels. This service life is understood to accommodate 90% reliability and conventional operating conditions. It may be necessary in certain applications to calculate the service life for a different level of reliability or for specific lubrication and contamination conditions.

With steels for high-quality bearings, it is possible, for low loads and under favourable operating conditions, to obtain extremely long service lives compared to L₁₀. A shorter service life than L₁₀ may apply under unfavourable operating conditions.

Below a certain load C_u (defined in the ISO 281 standard as "the fatigue load limit"), a modern high-quality bearing can achieve a practically infinite service life if the lubrication conditions, cleanliness and other operating conditions are favourable.

This load C_u can be determined precisely according to:

- The types of bearing
- Their internal geometry
- The fatigue limit of the raceway material

ADJUSTED NOMINAL SERVICE LIFE

The ISO 281 standard provides the necessary formula for obtaining a sufficient approximation based on the static capacity of the bearing.

- **The ISO 281** international standard introduces a correction factor of duration a_{ISO} which enables an adjusted nominal service life to be calculated according to the formula:

$$L_{nm} = a_1 a_{ISO} L_{10}$$

The coefficient a₁ is designed to calculate the duration for a reliability level different to 90% of the original formula.

The coefficient a_{ISO} is used to estimate the influence of the lubricant and of the contamination on the bearing service life. It takes account of the fatigue limit of the bearing steel.

Since the evaluation method for a_{ISO} defined by ISO 281 is fairly difficult to apply by a non-specialist user, NTN-SNR has looked for the best way to supply its customers with an easy way of determining a_{ISO} based on the hypotheses of the standard.

- > that the fatigue load C_u depends directly on the static capacity of the bearing
- > that the contamination factor is constant whatever the lubrication conditions and the average diameter of the bearing.

The method proposed by NTN-SNR enables rapid, graphic evaluation of the coefficient a_{ISO}. Our engineers are at your disposal to determine this coefficient more precisely if required.

METHOD FOR DETERMINING a_{ISO} (ISO 281)

The following diagram can be used to determine a_{ISO} for double-row spherical roller bearings according to the following method:

1. Define the viscosity of the lubricant at the operating temperature based on the diagram on page 30.
Determine the viscosity of the base oil for greased bearings.
2. Define the pollution level:
 - **High cleanliness**
Oil filtered through an extremely fine filter; usual conditions for bearings that are greased for life and sealed.
 - **Normal cleanliness**
Oil filtered through a fine filter; usual conditions for bearings that are greased for life and equipped with a shield.
 - **Slight contamination**
Slight contamination in the lubricant
 - **Typical contamination**
Oil with coarse filtration; presence of wear and tear particles or particles from the surrounding environment.
Usual conditions for lubricated bearings with no integrated seal.
 - **For major contamination**, consider that a_{ISO} will be less than 0.1
3. Based on the loads applied to the bearing, calculate the equivalent load P and the static capacity / equivalent load ratio: C_0 / P .
4. In graph 1 on page 29, determine point 1 according to the pollution level and the value C_0 / P .
5. Determine point 2 based on the average diameter of the bearing: $D_m = (\text{bore} + \text{outer diameter}) / 2$
6. Determine point 3 according to the rotational speed of the bearing.
7. Determine point 4 according to the viscosity of the lubricant at the operating temperature.
8. Point 5 at the intersection between the straight lines deriving from points 2 and 4 defines the value zone for a_{ISO} .

Roller bearings: estimation of coefficient a_{iso}

5 a_{iso}

Favourable operating conditions
 Uncertain operating conditions
 Unfavourable operating conditions

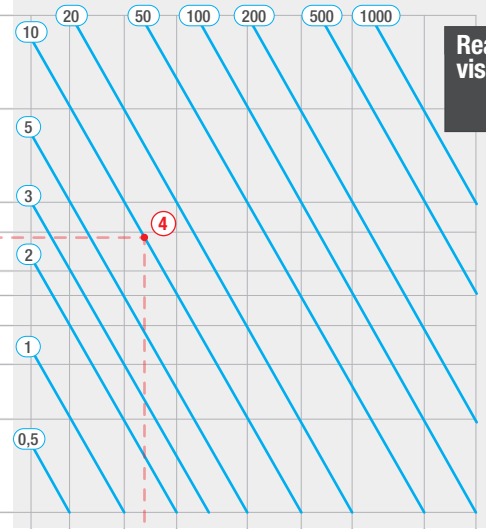
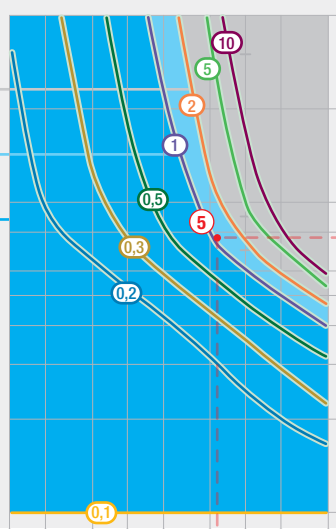

4 Real kinematic viscosity (cSt)

2 D_m (mm)

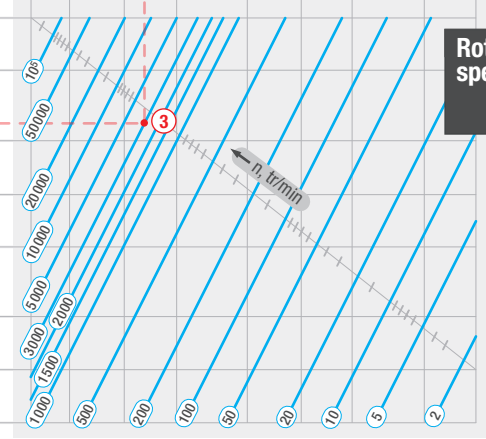
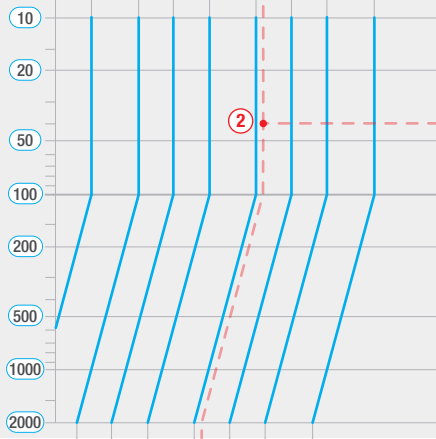

3 Rotation speed (rpm)

1 Load (C_0/P) and contamination*

- High cleanliness
- Normal cleanliness
- Light contamination
- High contamination

* Levels defined according to ISO 281

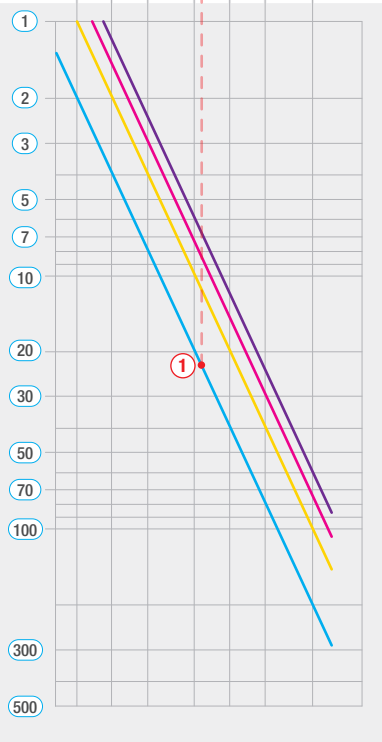

Example of determining the a_{iso} for a roller bearing:

- Point 1: functioning with typical pollution, with a charge level $C_0/P = 22$
- Point 2: with an average diameter D_m of 40 mm
- Point 3: rotation speed of 3,000 rpm
- Point 4: and with a lubricant of viscosity 10 cSt
- Point 5: the coefficient a_{iso} is: 1

DETERMINING THE MINIMUM VISCOSITY REQUIRED FOR THE OPERATING TEMPERATURE

VISCOSITY-TEMPERATURE DIAGRAM

The oils used for lubricating bearings are generally mineral oils with a viscosity in the vicinity of 90. The suppliers of these oils state the precise characteristics of their products and, in particular, the viscosity-temperature diagram. Failing this, the following general diagram will be used.

Since the oil is defined by its nominal viscosity (in centistokes) at the nominal temperature of 40°C, the viscosity at the operating temperature may be deduced.

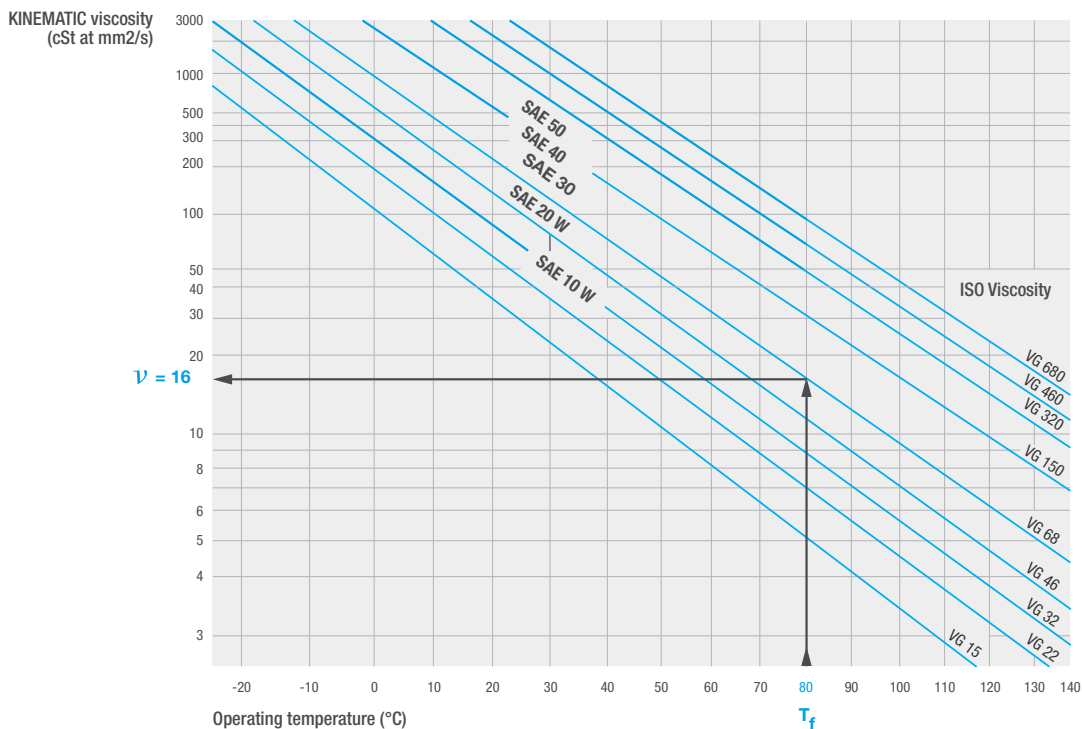

SPEEDS

THERMAL REFERENCE SPEED N_{OR}

The thermal reference speed is the rotational speed of the inner ring at which a thermal equilibrium is attained between the heat produced by the friction in the bearing and the heat flow emitted via the contact surface (shaft and housing) of the bearing under reference conditions.

The reference speed values indicated in the tables are in compliance with standard ISO 15312. The reference conditions for this standard have been chosen to apply both for oil lubrication and for grease lubrication. This standard applies to bearings up to and including a bore diameter of 1000 mm.

Thermal reference speed n_{Or} : speed at which the bearing temperature reaches +70°C under the reference conditions.

REFERENCE CONDITIONS DETERMINING THE FORMATION OF HEAT THROUGH FRICTION:

- Reference temperature of the bearing on the stationary outer ring Θ_r : 70°C
- Reference ambient temperature of the bearing Θ_{Ar} : 20°C
- Reference load $P_{1r} = 0.05 \times C_{Or}$ (5% of the basic static radial load, as pure radial load)
- Lubricant: high-pressure, additive-free mineral oil with, at $\Theta_r = 70^\circ\text{C}$, a kinematic viscosity of $\nu_r = 12\text{mm}^2/\text{s}$ (ISO VG32).

MATHEMATICAL CALCULATION ACCORDING TO STANDARD ISO 15312

$$\frac{\pi \cdot n_{\theta r}}{30 \cdot 10^3} \cdot [10^{-7} \cdot f_{\theta r} \cdot (v_r \cdot n_{\theta r})^{2/3} \cdot d_m^3 + f_{1r} \cdot P_{1r} \cdot d_m] = q_r \cdot A_r$$

$n_{\theta r}$: Thermal reference speed

$f_{\theta r}$: Adjustment factor for the moment of friction independent of the load (the values as per ISO 15312 are for information purposes only)

f_{1r} : Adjustment factor for the moment of friction depending on the load (the values as per ISO 15312 are for information purposes only)

v_r : Kinematic viscosity of the lubricant

d_m : Average diameter of the bearing $D_m = 0.5(D+d)$

q_r : Reference thermal flow density $q_r = 0.016 \text{ W/mm}^2$. If $A_r > 50000 \text{ mm}^2$ then $q_r = 0.016(A_r/50000)^{-0.34}$

A_r : Reference thermogenic surface area $A_r = \pi \times B(D+d)$

LIMITING SPEED

The limiting speed is the maximum permissible speed which depends on the mechanical limits, such as the tensile strength of the constituent parts of the bearing.

The limiting rotational speed is based on practical experiments. It takes account of additional criteria such as silent operation, the seal functions, the stability or resistance of the cage, the lubrication of the cage guide surfaces, the centrifugal and gyrating forces that act on the rolling elements and other speed limitation factors.

THERMALLY SAFE OPERATING SPEED

The admissible rotational speed n_{adm} is the rotational speed at which the average temperature of the bearing reaches the permissible limiting value under actual operating conditions. To determine the thermally safe operating speed of the bearing in its application, it is necessary to take account of the influence of the load and of the kinematic viscosity on the reference speed. When the load and viscosity parameters are in excess of the reference values, the friction resistance will increase and the temperature of the bearing will be higher. In this case, the bearing cannot operate at the thermally safe reference speed unless higher temperatures are permitted by the bearing and its application.

The influence of the load and of the kinematic viscosity of the lubricant may be determined on the basis of diagrams 1 and 2, page 36.

To determine the permissible speed of your bearing (see from page 54)

OIL LUBRICATION

- f_p : for the influence of the equivalent dynamic load P
- f_v : for the influence of the viscosity

If the reference temperature needs to remain constant at 70°C, the thermally safe operating speed is determined based on:

$$n_{adm} = n_{\theta r} \cdot f_p \cdot f_v$$

n_{adm} = thermally safe operating speed of the bearing, rpm

$n_{\theta r}$ = thermal reference speed

f_p = adjustment factor for the equivalent dynamic load P

f_v = adjustment factor for the oil viscosity

GREASE LUBRICATION

The diagram for determining factor f_v is also suitable for grease lubrication. In this case, the standard stipulates a kinematic viscosity of the base oil of between ISO VG 100 and ISO VG200 at +40°C with a quantity of grease equal to 30% of the free volume in the bearing.

To determine factor f_v in the case of grease lubrication, select the value of f_v from diagram 1 for the viscosity of the base oil at +40°C for the chosen grease and divide by f_v for the viscosity of the base oil ISO VG 150 (average value of the base oils permitted by the standard)

$$n_{adm} = n_{\theta r} \cdot f_p \cdot \frac{f_v \text{ real viscosity of the base oil}}{f_v \text{ viscosity of the base oil ISO VG 150}}$$

Example

An NTN-SNR ULTAGE 22216EA spherical roller bearing with a factor of $P/C_0=0.2$ lubricated with an oil of oil viscosity of ISO VG 220 mm^2/s at 40°C.

$$d_m = 0.5(80+140) = 110\text{mm}$$

$$n_{\theta r} = 4200 \text{ rpm}$$

$$\text{In diagram 1: } f_v = 0.83$$

$$\text{In diagram 2: } f_p = 0.5$$

The thermally safe operating speed in these conditions is:

$$N_{adm} = 4200 \times 0.83 \times 0.5 = 1740 \text{ rpm}$$

Diagram 1: correction factor f_v

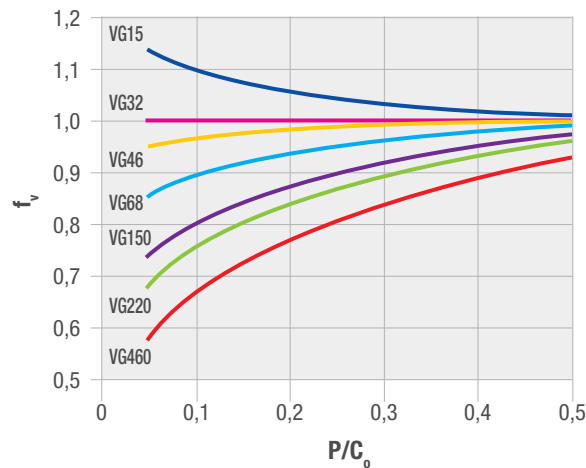
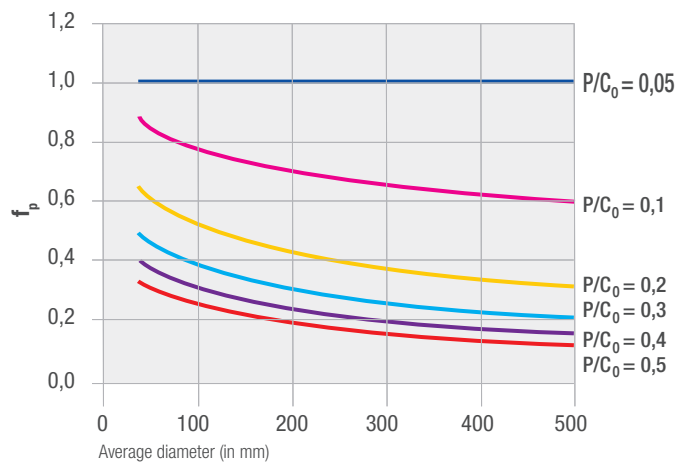

Diagram 2: correction factor f_p



In the case of operation at speeds approaching the limits stated in the bearing tables, please contact your NTN-SNR representative.

LUBRICATION

Only correct lubrication will guarantee optimal operation of the bearing and of the associated mechanical unit.

Our field experience shows that:

- 55% of premature faults with bearings result from inappropriate lubrication
- imperfect lubrication significantly reduces the service life of the bearing

Lubrication operations are often neglected on account of the difficulty of accessing the bearings and inadequate knowledge of the properties of many lubricants on the part of the user.

Since the choice of lubricant, the method of lubrication, the precise quantity to inject into the bearing and the monitoring frequency need to be studied carefully, our teams are on hand to advise you.

PRINCIPLE AND BENEFITS OF GOOD LUBRICATION

- By interposing a film of lubricant (oil film) between the rolling elements and the raceway, lubrication prevents wear and tear and seizure of the elements through metal-to-metal contact.
- It also protects the parts from corrosion.
- It provides a seal against liquids and external pollution and eliminates the impurities created by the movement of the parts.
- It reduces friction, and therefore limits the power consumed by the machine, thereby reducing energy costs.
- In the case of oil circulation, it evacuates the heat build-up and thus contributes to the thermal equilibrium of the machine.

The service life of the bearing is directly linked to the efficiency of the oil film, which depends:

- On the characteristics of the lubricant and therefore on its capability to resist high temperatures and vibrations, etc.
- On the load conditions and the bearing rotation speed

General-purpose greases do not always correspond to the specific requirements of certain applications. Since the bearings have to operate under conditions of high load, speed or temperature, or in the presence of water, humidity or vibrations, they require the use of carefully-selected lubricants.

NTN-SNR has consistently been involved in research in this field with the world's top lubricant manufacturers. In this way we have built up knowledge and practical experience of most of the lubricants applicable to bearings.

CHOICE OF LUBRICANT TYPE

	OIL LUBRICATION	GREASE LUBRICATION
BENEFITS	<ul style="list-style-type: none"> • Good bearing penetration • Good physical-chemical stability • Cooling • Easy control of the lubricant: state and levels 	<ul style="list-style-type: none"> • Cleanliness of the mechanism • Easier to ensure a good seal • Protective barrier • Easy assembly • Easy handling • Reduced or zero lubricant top-ups • Possible use of pre-lubricated bearings
DRAWBACKS	<ul style="list-style-type: none"> • Perfect seal required on assembly • In the event of prolonged stoppage, poor protection against oxidisation and humidity • Start-up delays when independent circulation prior to rotation is required 	<ul style="list-style-type: none"> • Higher friction coefficient than with oil • Inferior heat evacuation • Replacement (if needed) requires removal and cleaning of the bearing • No possibility of checking the grease level, therefore necessary to use a reliable grease or periodically top-up in order to compensate for leakage, pollution or ageing

CHARACTERISTICS OF GREASES

A grease is a semi-fluid to solid product obtained by dispersal of a thickening agent (soap) in a lubricating liquid (mineral or synthetic oil).

To provide certain specific properties, additives may be included. The growing use of bearings lubricated with grease, associated with the development of lifelong lubrication, makes the grease an integral component of the bearing. The service life of the bearing and its behaviour in various environments are largely determined by the properties of the grease used.

PHYSICAL-CHEMICAL CHARACTERISTICS

Consistency

- The NLGI (National Lubrication Grease Institute) grade corresponds to a penetration value in the grease used (according to test specification ASTM/D217).
- For bearings, the chosen consistency is in general grade 2.

NLGI GRADES	PENETRATION	Consistency
0	385 - 355	Semi-fluid
1	340 - 310	Very soft
2	295 - 265	Soft
3	250 - 220	Mean
4	205 - 175	Semi-hard

Viscosity of the base oil: generally defined in cSt (mm²/s) at 40°C

Density: in the region of 0.9

Drop point: temperature at which the first liquefied drop falls following heating of a sample

Order of magnitude: 180°C/260°C depending on the constituent components of the grease. The maximum temperature of use of the grease is always far below the drop point.

FUNCTIONAL SPECIFICATIONS

The working conditions to which the lubricant is subjected (rolling, blending) require special bearing greases that cannot be selected exclusively on the basis of their physical-chemical characteristics.

The NTN-SNR Research & Testing centre is constantly carrying out approval tests on bearings to allow us to provide advice about the grease best suited to a given application.

The approval specifications relate to the following basic criteria:

- Endurance of ball bearings
- Endurance of roller bearings
- Water resistance
- Resistance at high and low temperatures
- Adherence (centrifugation)
- Resistance to vibrations (false brinelling)
- Resistance to high speeds

These criteria may be supplemented depending on the result that the customer seeks. Grease selection for a particular application is a compromise carried out on the basis of the technical specifications of the application.

For further information about the technical characteristics of lubricants and their selection criteria, please consult our Experts & Tools catalogues or contact your NTN-SNR representative.

Tools for calculating bearing lubrication needs

CHOICE OF LUBRICANT VISCOSITY (OIL OR GREASE)

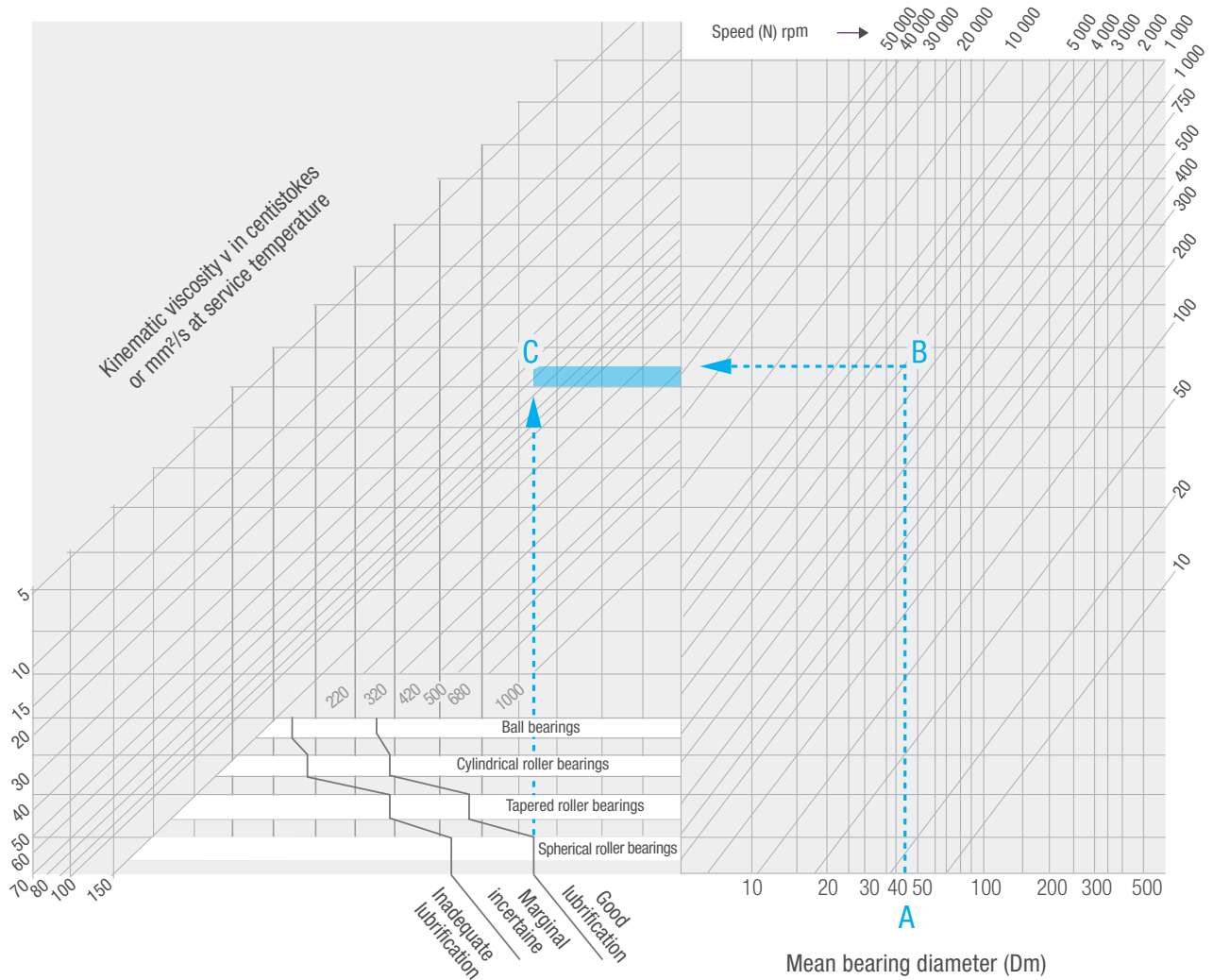

- Determine the average diameter of the bearing $A = (\text{Bore} + \text{outer diameter})/2$
- Find, by following point B on the graph, the intersection with the bearing rotation speed line
- Identify point C, intersection of the horizontal line deriving from B and the vertical line starting from the efficient lubrication limit, according to the type of bearing
- Determine the value of the oblique line passing via C (60 in the present case)
- Calculate the viscosity of the lubricant to be chosen, taking account of the operating temperature of the bearing

On the vertical scale (table on page 30), note the value of the calculated basic viscosity.

Identify the intersection between this value and the operating temperature of the bearing

The desired viscosity is the value of the oblique line passing via this intersection (approximately SAE 50, or VG300 in the present case)

DOSAGE OF LUBRICANTS AND RELUBRICATION

OIL LUBRICATION (MINIMUM QUANTITY)

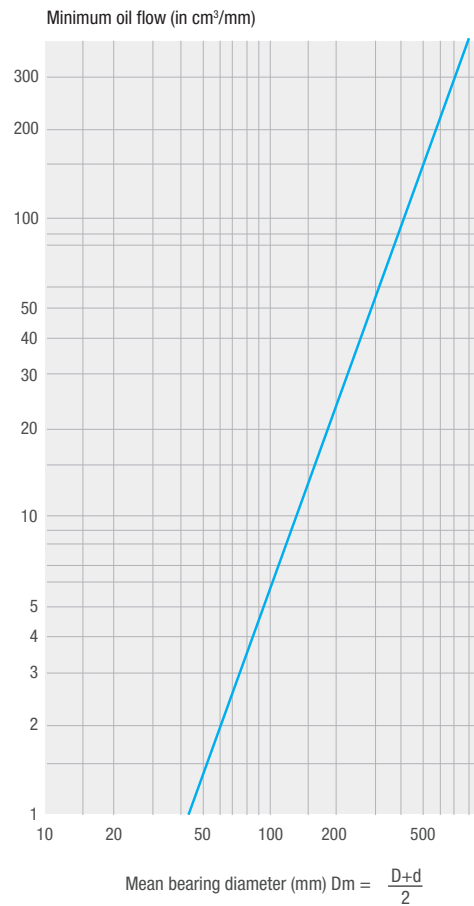

LUBRICATION WITH GREASE (DOSAGE)

Excessive grease may cause overheating.
The grease must occupy 20 to 30% of the free volume inside the bearing.

Calculation formula for the weight of grease required:
 $G = 0,005 D.B$

G = Gram (or cm³)
D = External diameter of the bearing in mm
B = Width of the bearing in mm

Exceptions:

- The quantity of grease may be increased by 20% for housings equipped with a grease evacuation orifice
- A bearing rotating at very low speed will tolerate complete filling

RELUBRICATION FREQUENCY

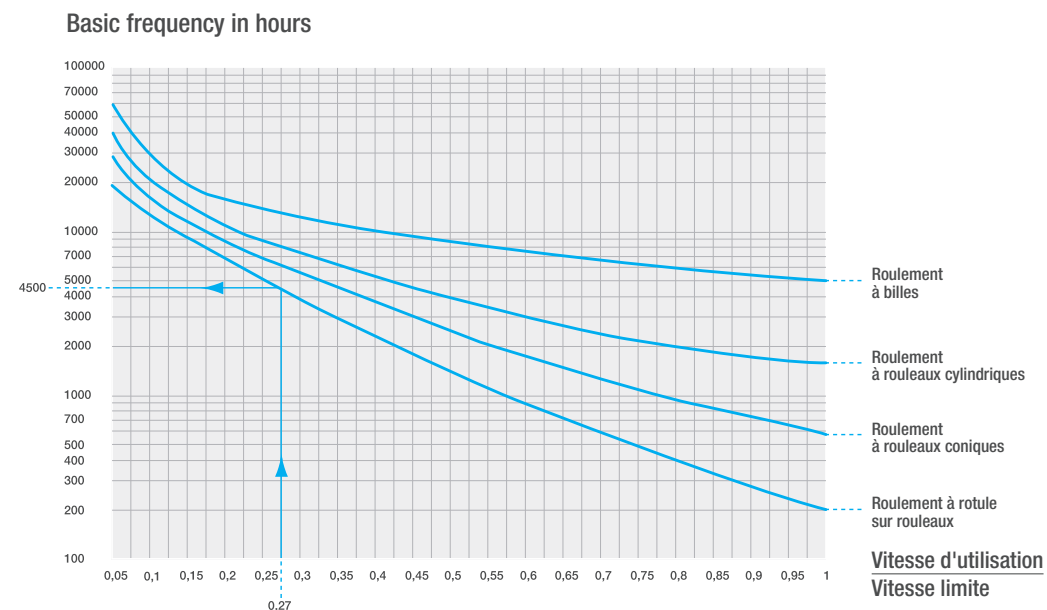

The basic relubrication frequency (F_b) depends on the type of bearing and the ratio of the speed of usage to the limiting speed stated in the bearing specifications.

This basic frequency needs to be adjusted by the following coefficients according to the specific environmental conditions of the mechanism (dust, humidity, impacts, vibration, vertical axis, operating temperature, etc) according to the relation: $F_c = F_b \times T_e \times T_a \times T_t$

Conditions	Environment	Applications	Temperature		
	Dust Humidity Condensation	With impacts Vibrations Vertical axis	Level	For standard grease	For high-temperature grease
Coefficients	T_e	T_a		T_t	T_t
Mean	0.7 to 0.9	0.7 to 0.9	75°C	0.7 to 0.9	-
High	0.4 to 0.7	0.4 to 0.7	75°C to 85°C	0.4 to 0.7	0.7 to 0.9
Very high	0.1 to 0.4	0.1 to 0.4	85°C to 125°C	0.1 to 0.4	0.4 to 0.7
	-	-	130°C to 170°C	-	0.1 to 0.4

Example: a 22212EA bearing, lubricated with standard grease, turning at 1500 rpm in a dusty environment, at 90°C with no other application constraints:

22212 = spherical roller bearing

Thermal reference speed $n_{\theta r} = 5600$ rpm

Utilisation speed = 1500 rpm

$$\frac{\text{Utilisation speed} = 1500 \text{ rpm}}{n_{\theta r} \text{ speed} = 5600 \text{ rpm}} = \frac{1500}{5600} = 0.27 \longrightarrow \text{Basic frequency } F_b = 4500 \text{ h}$$

$$\text{Adjusted frequency } F_c = 4500 \times 0.5 \times 0.9 \times 0.3 = 600 \text{ h}$$

$T_e = 0.5 \longrightarrow$ dust
 $T_a = 0.9 \longrightarrow$ normal
 $T_t = 0.3 \longrightarrow$ 90°C

WEIGHT OF GREASE TO BE RENEWED

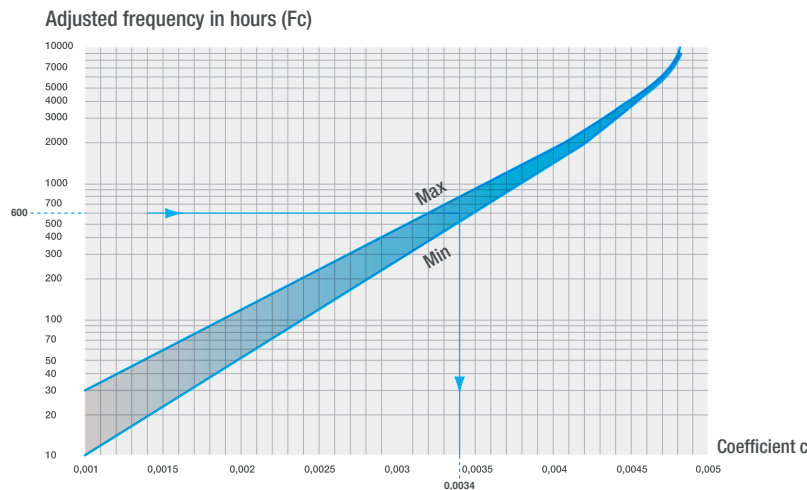

The adjusted frequency is used to determine the weight of the grease to be used, according to:

- The bearing width B
- Its outer diameter D
- Coefficient c read off the curve by the relation $P = D \times B \times c$ where P = weight of grease (gram)

Example:

for the 22212

(D = 110, B = 28, c = 0.0034)

$P = 110 \times 28 \times 0.0034 = 10$

We shall therefore add approximately 10 g every 600 hours of operation.

In first approximation, we may consider the following values:

FLOW RATE ADJUSTMENT PARAMETERS

Shaft diameter	Manual lubrication frequency (one pump action = 1 cm ³)	Quantity per day	Frequency of replacement of automatic lubricator 120 to 130 cm ³
100 to 120 mm	4 pump actions per day	3 to 4 cm ³	1 month
80 to 100 mm	2 pump actions per day	2 cm ³	2 month
65 to 80 mm	8 to 10 pump actions per week	1.5 cm ³	3 month
50 to 65 mm	8 to 10 pump actions every 15 days	0.7 cm ³	6 month
< 50 mm	8 to 10 pump actions per month	0.3 cm ³	12 month

ADJUSTMENTS

Conditions	Shaft diameter (mm)		ISO tolerance of the shaft	Comments	
	>	≤			
Cylindrical bore bearing (Class 0)					
Rotating inner ring load or indefinite direction load	Light load (1) standard (1) or varying load	18	25	k5	
		25	40	m5	
		40	60	n5	
		60	100	n6	
		100	200	p6	
		200	500	r6	
Static inner ring load	Heavy load or impact load (1)	50	70	n5	Requires a bearing with a radial clearance greater than CN.
		70	140	p6	
		140	200 (2)	r6	
	Inner ring should slide smoothly on shaft	All shaft diameters		g6	For large bearings, tolerance f6 may be applied to ensure that the bearing is capable of moving freely.
Inner ring may not slide smoothly on shaft	All shaft diameters		h6		
Tapered bore bearing (Class 0; complete with an adapter or mounting sleeve)					
All types of load	All shaft diameters		h9/IT5 (3)	h10/IT7 (3) will be sufficient for power transmitting shafts.	

1 Criteria for light, standard and heavy loads.

Light loads:	Dynamic equivalent radial loads $\leq 0.05 C$
Standard loads:	$0.05 C < \text{Dynamic equivalent radial loads} \leq 0.10 C$
Heavy loads:	$0.10 C < \text{Dynamic equivalent radial loads}$

2 If using shaft diameter over 200 mm with impacts or heavy loads, please contact our NTN-SNR experts.

3 "IT5" or "IT7" means that the shaft form tolerance (circularity, cylindricity, etc.) must satisfy tolerance class IT5 or IT7.

Note 1: the table above table applies to solid steel shafts.

Note 2: please use the following formula to calculate the required interference; it determines the value to 1/1000 of the maximum shaft diameter:

If $F^r \leq 0.3C_0$	Required interference $\Delta dF(\mu\text{m})$ is $\Delta dF = 0.08 \cdot (d^*F^r/B)^{1/2}$
If $F^r > 0.3C_0$	$\Delta dF = 0.02 \cdot (F^r/B)$

(d = Bearing bore (mm) / B = Inner ring width (mm) / F^r = Radial load / C_0 = Basic static load)

By taking account of the difference between the ambient temperature and the temperature of an in-service bearing, the appropriate effective interference must be used according to the temperature difference $\Delta T(\mu\text{m})$.

$$\Delta dF = 0.0015 \cdot d^* \Delta T$$

(ΔT corresponds to the temperature difference between the bearing in continuous service and the external ambient temperature in °C)

Housing	Conditions		ISO tolerance of the housing	Comments	
	Type of load, etc.	Axial displacement of the outer ring			
Single or two-part housing	Static outer ring load	All types of load	Movable	H7	When a large bearing is used or in case of a significant temperature difference between the outer ring and the housing, tolerance G7 may be applied
		Light load (1) or standard load (1)	Movable	H8	-
		High heat build-up in the shaft and inner ring	Easily movable	G7	When a large bearing is used or in case of a significant temperature difference between the outer ring and the housing, tolerance F7 may be applied
Single housing		Precision rotation must be possible under light to standard load	Generally immovable	K6	-
			Movable	JS6	-
		Very light load	Movable	H6	-
	Indefinite direction load	Light to standard load	Movable	JS7	-
		Standard to heavy load (1)	Generally immovable	K7	-
		High-impact load	Immovable	M7	-
	Rotating outer ring load	Light load	Immovable	M7	-
		Standard to heavy load (1)	Immovable	N7	-
		High impacts or heavy loads on thin-walled housings	Immovable	P7	-

1 Criteria for light, standard and heavy loads

- Light loads: Dynamic equivalent radial loads $\leq 0.05 C$
- Standard loads: $0.05 C < \text{Dynamic equivalent radial loads} \leq 0.10 C$
- High loads: $0.10 C < \text{Dynamic equivalent radial loads}$

Note: the table above applies to steel or cast-iron housings



PRACTICAL INFORMATION

Mounting and removal	42
Fitting & removal tools	48
Services	49

PRACTICAL INFORMATION

MOUNTING AND REMOVAL

Mounting the bearing is an essential stage that determines the service life and proper functioning of the installation. Feedback has shown that incorrect mounting is the cause of 17% of bearing faults remove out in the field.

COLD MOUNTING

Cold mounting is the simplest mode of assembly.

It is particularly suited to small and medium-sized bearings with a moderately tight adjusting.

NTN-SNR RECOMMENDATIONS

Rule 1 the bearing must be firmly fixed to the rotating part

	Analysis of rotation (% Incidence)		Fixing principle
Load fixed in relation to the outer ring (frequency of cases)	Stationary housing and load (95%) Rotating inner ring	Rotating housing and load (0.5%) Stationary inner ring	Inner ring tight on shaft
	Stationary shaft and load (3%) Rotating outer ring	Rotating shaft and load (1.5%) Stationary outer ring	

Rule 2 the sleeve is mounted by applying against the bearing ring with a tight adjusting or simultaneously on both rings. This avoids stressing the rotating body and damaging the bearing.

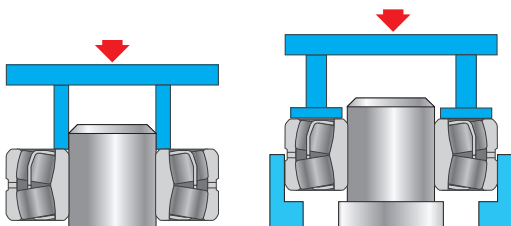

"For easier mounting and in order to avoid fretting corrosion with the shaft or housing":

- Always use NTN-SNR fitting compound. This thick lubricant preserves the surface quality of parts with mating surfaces. Without this compound, corrosion would progressively cause the adjusting between bearing and shaft (or housing) to deteriorate, ultimately leading to vibrations and ring rotation, causing premature damage to the bearing and the mating surfaces.
- Avoid introducing any pollutant during assembly (metal chips, liquid, etc.)

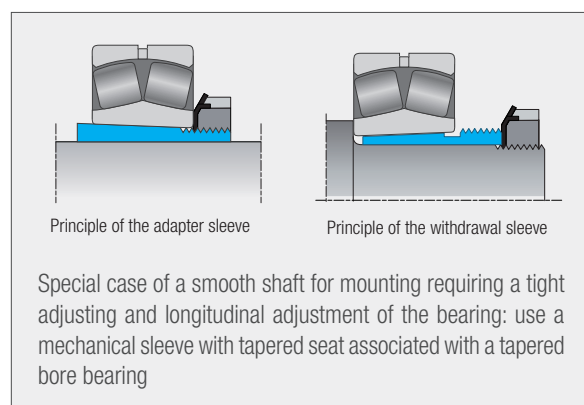

HOT MOUNTING

hot mounting: raising the temperature of the inner ring causes it to expand in order that it can fit effortlessly onto its shaft.

- In the event of tight adjusting on the outer ring, prior to the insertion of the bearing, the housing may be made to expand through heating.
- Conversely, a shaft or a bearing ring can also be frozen using liquefied gas in order to facilitate insertion of the bearing.

NTN-SNR's induction heaters provide the best solution in terms of safety, cleanliness and speed compared with oil-bath heating, hot plates or ovens.

Heating using a blowtorch is to be prohibited. This may generate temperatures locally that alter the hardness of the bearing, and therefore shorten its service life.

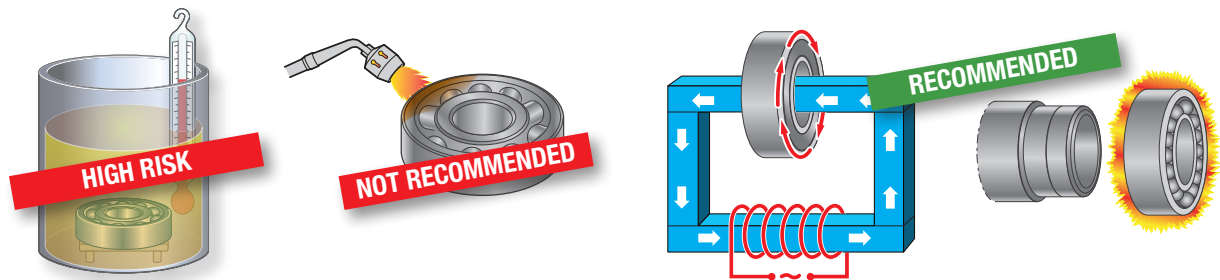

Keeping the temperature under control is vitally important for hot-mounting parts correctly.

Therefore, depending on the bearing dimensions, the following temperatures are recommended:

Bore diameter	T° heating temp
Up to 100 mm	+90°C
100 to 150 mm	+120°C
Over 150 mm	+ 130°C

Bearings with seals should not be heated above 80°C.

Heating too fast and too much can alter the properties of the material and significantly reduce the life of the bearing.

However, expanding the inner ring too quickly relative to the outer ring, can subject the rolling housings to significant stresses that can lead to their deterioration or that of the raceway.

ONE SENSOR TWO SENSORS

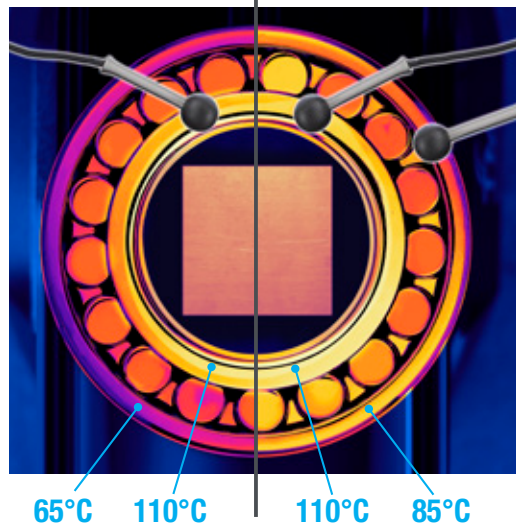

"A function such as the Temperature mode with 2 probes of SmartTEMP devices makes it possible to control the temperature delta between the rings."

HYDRAULIC MOUNTING

The mounting of large bearings with tapered bores requires considerable effort that is difficult to produce by mechanical screw tightening. The use of hydraulic technology is required in such cases.

Oil is injected under high pressure to create an oil film over the whole of the contact surface between the seat and the inner ring. This reduces the friction generated by the mounting and facilitates tightening of the nut. A hydraulic nut can be used at the same time to develop the necessary mounting force.

The two principles may also be used simultaneously to make mounting easier. The residual clearance is checked using feeler gauges or a comparator which measures the sink depth on the tapered seat.

TWO TYPES OF MOUNTING ARE SUITED TO THIS METHOD:

Cylindrical shaft associated with an adapter sleeve

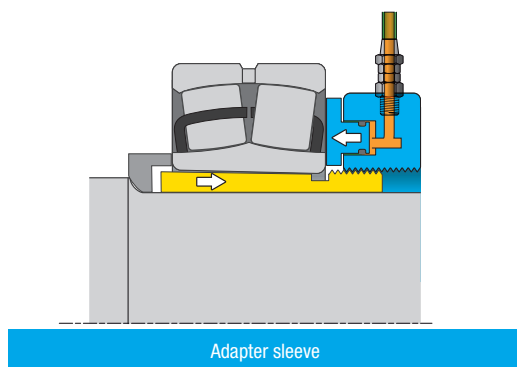

Mounting on adapter sleeve with a hydraulic nut

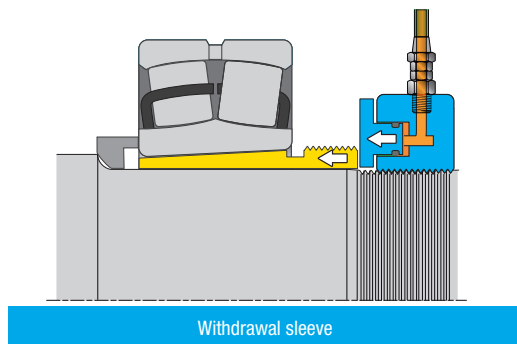

Mounting on withdrawal sleeve by indirect pushing of the hydraulic nut

Note: You could use the same hydraulic nut for assembly and disassembly.

On a tapered seat

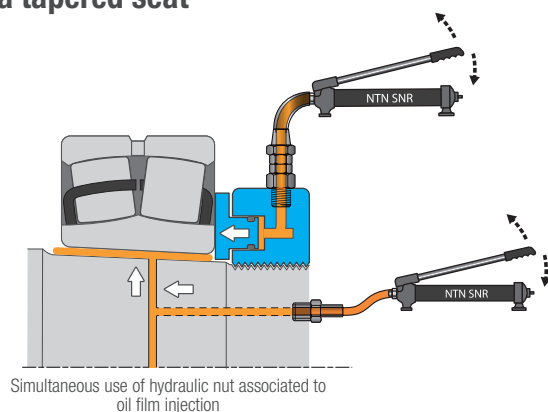

"For bore diameters above 60 mm, a hydraulic solution must be used."

CHECKING THE INTERNAL RADIAL CLEARANCE ON ASSEMBLY

AXIAL CLEARANCE

Since the axial clearance J_a is a function of the radial clearance J_r , it can be calculated by means of the following approximation formula:

$$J_a = 2.27 Y_0 \cdot J_r$$

WHY IS IT IMPORTANT TO MEASURE THE RADIAL CLEARANCE?

Spherical roller bearings with two rows of tapered bore can be mounted in various ways:

- By using an adapter sleeve (1)
- A withdrawal sleeve (2)
- Or directly on the tapered shaft seat (3)

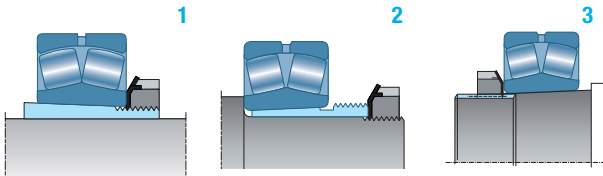

Locking the nut allows the bearing to be tightened. This causes the inner ring to expand and reduces the internal clearance.

To prevent the bearing from locking due to too great a reduction in clearance, it is necessary to check the degree of tightness of the nut. The tightness is checked by measuring the bearing clearance before and after mounting.

Prior to measurement of clearance

Locate the radial clearance before mounting (catalogue data) shown in the table on the following page (see blue area).

Bearing clearance is measured with feeler gauges.

Place the bearing in a vertical position, facing, with the rollers in line with the bearing.

Turn the bearing manually in order to put the rollers in place.

Radial clearance measurement

The bearing must be held still during this measurement.

The feeler gauges are used as follows.

Slide them at an angle between the outer ring raceway and the rollers without load, without rotating the bearing.

Start with the mini gauge and insert gauges of increasing thickness until the value of the radial clearance is reached.

The actual radial clearance value is located between the gauge that passes and the one that fails to pass.

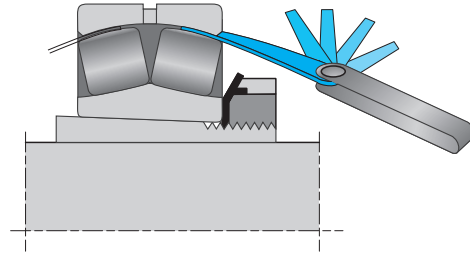

How to measure the clearance after mounting?

There are two ways to check that the clearance has been correctly reduced after mounting:

- **Using feeler gauges:** proceed in the same way as above (see green area in the table on the following page)
- **By axial displacement:** using a comparator and a hydraulic pump, position the bearing within the range of corresponding values indicated by the rest blade (see grey area in the table on the following page)



During tightening, monitor the reduction of clearance so that the prescribed limit is not exceeded.

SPECIAL CASE: SEALED BEARINGS

Only the axial displacement can be checked to obtain the right radial clearance that also corresponds to a rotation in °.

The last column of the table contains our recommendations for the rotation of the nut in order to obtain the right axial displacement for your sealed bearing.

SPECIAL CASE: OVERSIZE BEARINGS

For large bearings, do not use feeler gauges larger than 15/100th of a mm, which are too rigid to fit the curve of the bearing raceway and prefer using a combination of thinner distance pieces.

If using an EE sealed spherical roller bearing, a feeler gauge cannot be used.

Bearing nominal bore (mm)		Before assembly According to ISO 5753 (mm)						After assembly Feeler gauge*						Axial displacement (mm)				Recommended rotation for the locking nut
>	≤	Normal CN		C3		C4		Normal CN		C3		C4		Taper 1:12		Taper 1:30		
		min	max	min	max	min	max	min	max	min	max	min	max	min	max	min	max	
24	30	0,03	0,04	0,04	0,055	0,055	0,075	1	3	2	5	4	7	0,15	0,2	-	-	-
30	40	0,035	0,05	0,05	0,065	0,065	0,085	1	4	3	5	4	7	0,25	0,3	-	-	65°
40	50	0,045	0,06	0,06	0,08	0,08	0,1	2	4	3	6	5	8	0,35	0,4	-	-	90°
50	65	0,055	0,075	0,075	0,095	0,095	0,12	2	5	4	7	6	10	0,4	0,45	-	-	75°
65	80	0,07	0,095	0,095	0,12	0,12	0,15	3	6	5	9	8	12	0,5	0,6	-	-	100°
80	100	0,08	0,11	0,11	0,14	0,14	0,18	3	7	6	10	9	14	0,6	0,7	-	-	120°
100	120	0,1	0,135	0,135	0,17	0,17	0,22	3	8	7	12	10	17	0,8	0,9	1,8	2,3	-
120	140	0,12	0,16	0,16	0,2	0,2	0,26	4	10	8	14	12	20	0,9	1	1,95	2,7	-
140	160	0,13	0,18	0,18	0,23	0,23	0,3	4	11	9	16	14	23	1	1,2	2,35	3,1	-
160	180	0,14	0,2	0,2	0,26	0,26	0,34	4	12	10	18	16	26	1,1	1,4	2,8	3,55	-
180	200	0,16	0,22	0,22	0,29	0,29	0,37	5	13	11	20	18	28	1,2	1,5	3,2	3,95	-
200	225	0,18	0,25	0,25	0,32	0,32	0,41	5	14	12	21	19	30	1,5	1,8	3,85	4,6	-
225	250	0,2	0,27	0,27	0,35	0,35	0,45	6	15	13	23	21	33	1,6	1,9	4,2	4,95	-
250	280	0,22	0,3	0,3	0,39	0,39	0,49	6	17	14	26	23	36	1,6	2,1	4,25	5,4	-
280	315	0,24	0,33	0,33	0,43	0,43	0,54	6	18	15	28	25	39	1,9	2,4	4,45	5,7	-
315	355	0,27	0,36	0,36	0,47	0,47	0,59	8	20	17	31	28	43	2,1	2,5	5,1	6,1	-
355	400	0,3	0,4	0,4	0,52	0,52	0,65	8	22	18	34	30	47	2,3	3	5,75	7,5	-
400	450	0,33	0,44	0,44	0,57	0,57	0,72	8	23	19	36	32	51	3	3,6	-	-	-
450	500	0,37	0,49	0,49	0,63	0,63	0,79	11	28	23	42	37	58	3,3	4	8,25	10	-
500	560	0,41	0,54	0,54	0,68	0,68	0,87	11	30	24	44	38	63	3,7	4,6	4	5,1	-

*Practical measurement of clearance per 1/100 mm using feeler gauges. The values less than 4/100 mm, use laminated shims.

Relation between the axial displacement (a) of a bearing with tapered bore and the corresponding reduction of its clearance J_r :

Taper 1/12 $a = 12 \Delta J_r / t_i$

Taper 1/30 $a = 30 \Delta J_r / t_i$

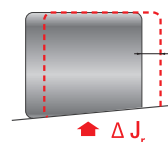

a = axial displacement
 J_r = radial clearance reduction

t_i = clearance reduction rate on inner ring: $t_i = 0.75$ if the bearing is directly mounted on a solid shaft tapered seat.
 $t_i = 0.7$ if the bearing is mounted on a tapered sleeve.

MECHANICAL DISMOUNTING

Dismount cleanly: look after your equipment and save time, safely.

Wherever possible, the bearing should be extracted by exerting force on the tightened ring. There are numerous types of extractor, depending on the grip offered by the bearing, its accessibility and the extraction force required.

Extractors equipped with a pump and hydraulic cylinder allow the operator to develop very high extraction efforts, using their own muscular strength. They are easy to use, due to the fact that their arms are self-centring.

To remove a damaged or oscillating bearing, slide a ring separator between the puller and bearing if possible.

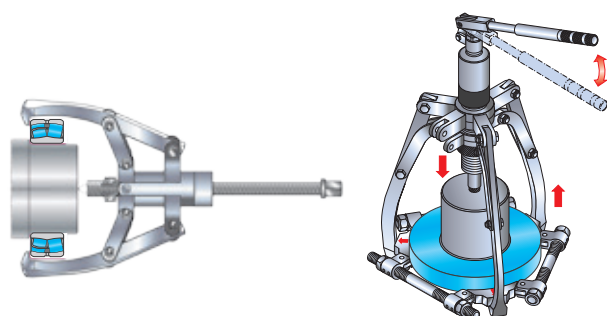

HYDRAULIC DISMOUNTING

bearing seats are equipped with distribution channels and grooves for removal by means of hydraulic pressurisation. Likewise, the NTN-SNR adapter and withdrawal sleeves are equipped with these devices for shafts of 200 mm and above.

This method is quick and reliable: it requires a high pressure pump with a maximum power rating in the case of tapered seats. In the case of a cylindrical seat, it is necessary to maintain high pressure and accompany this with the removal of the bearing using mechanical extraction methods.

If an adapter or withdrawal sleeve was used during mounting, a hydraulic nut can be used for quick and effortless dismounting.

HYDRAULIC DISMOUNTING ON ADAPTER / WITHDRAWAL SLEEVE

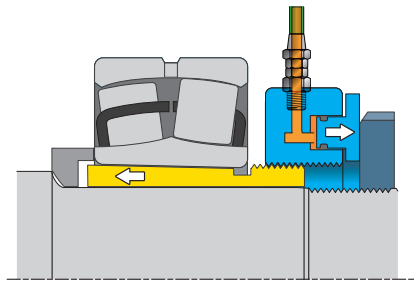

Screw the hydraulic nut on the adapter sleeve without pressing against the bearing.
Inject oil extraction up the sleeve.

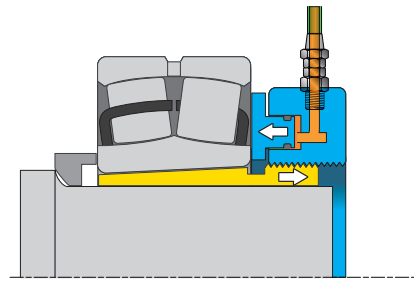

Screw the hydraulic nut on the sleeve removal, the piston in contact with the bearing.
Inject oil extraction up the sleeve.



Extraction of the adapter sleeve with a hydraulic nut



Extraction of the withdrawal sleeve with a hydraulic nut

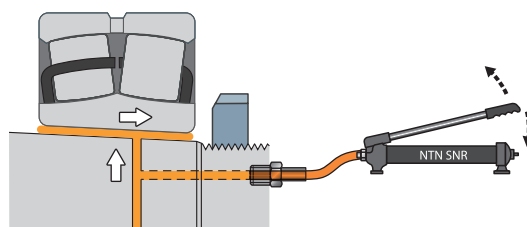

Principle of removing hydraulic oil injection channels

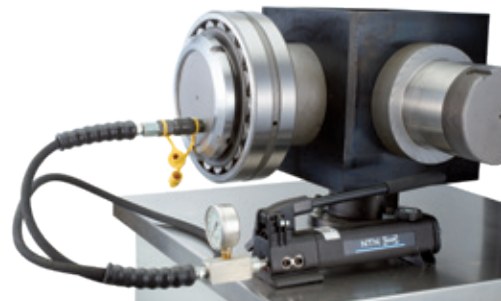

Hydraulic dismounting

FITTING & REMOVAL TOOLS

SmartTEMP

THE ONLY TOOL FOR THE SAFE, CONTROLLED HEATING OF BEARINGS, PINIONS, COLLAR RINGS, ETC.

Drawing strength from a 30-year track record in the professional induction heating market, NTN-SNR is now able to present its innovative new range of induction heaters. These new-generation heaters effectively address all your needs, from heating workpieces through to more sensitive parts that require cutting-edge technology for safe heating. Heaters are easy and safe to use with their touchscreen. The interface menu is displayed in the operator's language to maximise efficiency, the likes of which have never been seen before in the market.



ELIMINATE ALL RISKS WHEN MOUNTING BEARINGS

17%

of premature bearing failures are caused by poor mounting

CORRECT BEARING MOUNTING

is essential for increasing the service life

HOT MOUNTING METHOD

with the induction heater reduces any damage during assembly



COLD MOUNTING

Tool case for quick, accurate bearing fitting in complete safety.



DISMOUNTING TOOLS

Hydraulic or mechanical dismounting: All kinds of pullers (2 or 3 arms) for a safe and clean operation whatever the position and the size of the bearing.



HYDRAULIC MOUNTING

Precise, effortless with a revolutionary nut, always ready for use thanks to its "back & forth" feature!

SERVICES

Experts
& Tools

EXPERTS & TOOLS: THE NTN-SNR TEAM OF EXPERTS CAN SUPPORT YOUR ORGANISATION TO OBTAIN THE BEST PERFORMANCE FROM YOUR BEARINGS AND YOUR OPERATIONS



TRAINING

Improve the skills of your maintenance technicians and designers in bearing selection and maintenance. Whether at our training school or on your premises with our BEBOX van, we can provide made-to-measure training courses covering both theory and practice, because all customers are different.



DAMAGED BEARING DIAGNOSIS

Let our experts determine the causes of your bearing failures in our lab or on your site. Their reactivity and advice can provide the keys to your improvements.



TECHNICAL ASSISTANCE FOR BEARINGS AND LUBRICATION SYSTEMS

Rely on our experts to supervise your maintenance operations: bearing dismounting and fitting, lubrication system set-up and improvement, vibration analysis and so on.



MAINTENANCE AUDIT

Benefit from a unique appraisal of your maintenance organisation, performed by our plant maintenance managers. Gain productivity thanks to a pragmatic action plan resulting from a peer-to-peer approach.

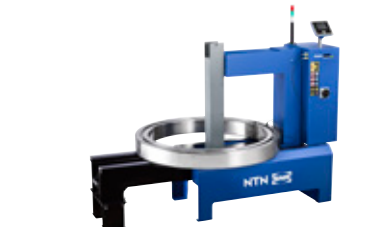

TOOL HIRE

Experts & Tools offers a wide range of large bearing maintenance tools for rent, whether induction heaters, hydraulic nuts or pumps.





LIST OF REFERENCES

Prefixes/suffixes	53
Spherical roller bearing references	54
Mounting / withdrawal sleeves	70
Associated plummer blocks	74
Lubrication products	76



LIST OF REFERENCES

PREFIXES / SUFFIXES

Prefixes	NTN/SNR	SKF	NSK	FAG	TIMKEN
Non-ISO ring width for LLS sealed version (NTN)	WA	BS2		WS2	
Non-ISO ring width for EE sealed version (SNR)	10X	BS2		WS2	
Suffixes - Internal design/Cage designation	NTN/SNR	SKF	NSK	FAG	TIMKEN
DESIGN					
Increased capacity design, symmetrical rollers	E "ULTAGE"	E "EXPLORER"	E "HPS"	E1 "X-LIFE"	E
Standard internal design, symmetrical rollers	V				C, VSC, Y
Optimised internal design, asymmetrical rollers	B				
CAGE					
Two steel plate cages with window centred on the inner ring	A	Without suffix, C, CC	A, C, CD	Without suffix, BE	EJ
KIZEI® range: Nitrided metal shields on both sides of the bearing	ZZ				
One-piece solid brass cage centred on rollers	M	CA, CAC	CAM, M	E1A, BEA, B-MB, M, MA, MB	EM
One-piece solid brass cage centred on rollers, for high-vibration applications, special clearances C4/C3/CN	F800 / F801 / F802	VA405	CAM...-VS4/-VS3	T41A, T41D	W800
Similar to EF800, NTN designation	EMD1V800	VA405	CAM...-VS4/-VS3	T41A, T41D	W800
Two glass fibre-reinforced polyamide cages	G15			TVPB (BI)	
Two solid machined brass cages centred on inner ring	L1	CA, CAC	CAM, M	E1A, BEA, B-MB, M, MA, MB	EM
Two solid carbon steel cages centred on inner ring	F1				
SEALING					
Reinforced seal properties (NBR) on both sides of the bearing. 30% grease-filled (SNR)	EE	2CS, 2RS		2RSR	
Low noise version (only with EE suffix)	L				
Reinforced seal properties (NBR) on both sides of the bearing (NTN)	LLS	2CS, 2RS		2RSR	
LUBRICATION GROOVE AND HOLES ON THE OUTER RING					
Lubrication groove and holes on the outer ring	D1 / W33	Without suffix, W33	E4	Without suffix, S	W33
Lubrication holes on inner ring	W34	W26		HA40AB	W94
Groove for stop segment on outer ring	N				
Suffixes - Bore type	NTN/SNR	SKF	NSK	FAG	TIMKEN
Cylindrical bore (without suffix)	-	-	-	-	-
Tapered bore, taper 1:12	K	K	K	K	K
Tapered bore, taper 1:30	K30	K30	K30	K30	K30
Suffixes - Radial internal clearance/Tolerances	NTN/SNR	SKF	NSK	FAG	TIMKEN
Internal radial clearance < C2	C1				
Internal radial clearance < Standard	C2	C2	C2	C2	C2
Standard internal radial clearance (without suffix)	CN	CN	CN	CN	CN
Internal radial clearance > Standard	C3	C3	C3	C3	C3
Internal radial clearance > C3	C4	C4	C4	C4	C4
Internal radial clearance > C4	C5	C5	C5	C5	C5
Special internal radial clearance	CSxx				
Class P5 rotation precision	P5	P5		P5	P5
Class P6 rotation precision	P6	P6		P6	P6
Inner/outer ring in P5 rotation precision	PX50	C08		T52BW	C08
Suffixes - Others	NTN/SNR	SKF	NSK	FAG	TIMKEN
Solid lubrication, SNR designation	LS0	W64, W64F, W64H, W64L	L11, L12		
Solid lubrication, NTN designation	LP03	W64, W64F, W64H, W64L	L11, L12		

NTN-SNR offers different solutions for countless applications. This is only a partial list of the most commonly used codes.

- Every reasonable effort has been made to guarantee the accuracy of the information in this table.

The information is provided for guidance only and NTN-SNR shall in no way be held liable.

- SKF Explorer, FAG X-life and NSK HPS bearings are trademarks registered by their respective companies.

SPHERICAL ROLLER BEARING REFERENCES

Overall dimensions			ULTAGE	Designations		Fatigue load limit	Dynamic load		Calculation factors			
d	D	B		Cylindrical bore	Tapered bore	C ₀	Dynamic C	Static C ₀	e	Y ₁	Y ₂	Y ₀
mm						kN						
25	52	18	*	22205EAW33	22205EAKW33	5,6	57,3	46,1	0,34	2	2,98	1,96
	52	18	*	22205EMW33	22205EMKW33	5,2	54,2	42,8	0,34	2	2,98	1,96
	52	23	*	10X22205EAW33EE	10X22205EAKW33EE	5,6	57,3	46,1	0,34	2	2,98	1,96
	62	17	*	21305V	21305VK	4,9	51,1	40,3	0,29	2,33	3,47	2,28
30	62	20	*	22206EAW33	22206EAKW33	7,9	75,7	64,5	0,31	2,15	3,2	2,1
	62	20	*	22206EMW33	22206EMKW33	7,3	71,9	60,2	0,31	2,15	3,2	2,1
	62	25	*	10X22206EAW33EE	10X22206EAKW33EE	7,9	75,7	64,5	0,31	2,15	3,2	2,1
	72	19	*	21306V	21306VK	6,1	64,6	52,1	0,28	2,45	3,64	2,39
35	72	23	*	22207EAW33	22207EAKW33	11,2	100	92	0,31	2,21	3,29	2,16
	72	23	*	22207EMW33	22207EMKW33	11,2	100	92	0,31	2,21	3,29	2,16
	72	28	*	10X22207EAW33EE	10X22207EAKW33EE	11,2	100	92	0,31	2,21	3,29	2,16
	80	21	*	21307EAW33	21307EAKW33	9,6	88,5	78,5	0,24	2,79	4,15	2,73
40	80	23	*	22208EAW33	22208EAKW33	12,8	116	105	0,27	2,47	3,68	2,41
	80	23	*	22208EAW33ZZ	22208EAKW33ZZ	12,8	116	105	0,27	2,47	3,68	2,41
	80	23	*	22208EMW33	22208EMKW33	12,0	110	98	0,27	2,47	3,68	2,41
	80	28	*	10X22208EAW33EE	10X22208EAKW33EE	12,8	116	105	0,27	2,47	3,68	2,41
	90	23	*	21308V	21308VK	10,6	97,7	86,7	0,26	2,55	3,8	2,5
	90	33	*	22308EAW33	22308EAKW33	18,5	169	152	0,36	1,87	2,79	1,83
	90	33	*	22308EMW33	22308EMKW33	18,5	169	152	0,36	1,87	2,79	1,83
	90	33	*	22308EF800	22308EKF800	18,5	169	152	0,36	1,87	2,79	1,83
45	85	23	*	22209EAW33	22209EAKW33	13,8	121	113	0,26	2,64	3,94	2,58
	85	23	*	22209EAW33ZZ	22209EAKW33ZZ	13,8	121	113	0,26	2,64	3,94	2,58
	85	23	*	22209EMW33	22209EMKW33	12,9	116	106	0,26	2,64	3,94	2,58
	85	28	*	10X22209EAW33EE	10X22209EAKW33EE	13,8	121	113	0,26	2,64	3,93	2,58
	100	25	*	21309EAW33	21309EAKW33	16,3	138	134	0,23	2,9	4,31	2,83
	100	36	*	22309EAW33	22309EAKW33	22,8	206	187	0,36	1,9	2,83	1,86
	100	36	*	22309EMW33	22309EMKW33	22,8	206	187	0,36	1,9	2,83	1,86
	100	36	*	22309EF800	22309EKF800	22,8	206	187	0,36	1,9	2,83	1,86
50	90	23	*	22210EAW33	22210EAKW33	15,1	130	124	0,24	2,84	4,23	2,78
	90	23	*	22210EAW33ZZ	22210EAKW33ZZ	15,1	130	124	0,24	2,84	4,23	2,78
	90	23	*	22210EMW33	22210EMKW33	14,3	125	117	0,24	2,84	4,23	2,78
	90	28	*	10X22210EAW33EE	10X22210EAKW33EE	15,1	130	124	0,24	2,84	4,23	2,78
	90	28	*	10X22210EAW33EEL	10X22210EAKW33EEL	15,1	130	124	0,24	2,84	4,23	2,78
	110	27	*	21310V	21310VK	16,3	142	134	0,25	2,71	4,04	2,65
	110	40	*	22310EAW33	22310EAKW33	28,3	250	232	0,36	1,87	2,79	1,83
	110	40	*	22310EMW33	22310EMKW33	28,3	250	232	0,36	1,87	2,79	1,83
	110	40	*	22310EF800	22310EKF800	28,3	250	232	0,36	1,87	2,79	1,83

Bearings available with cylindrical and tapered bores Bearings with tapered bores are generally fitted with adapter or withdrawal sleeves. All types of clearances are available from stock or on request. Special clearances and special precisions are available on request.

*NTN-SNR ULTAGE bearing

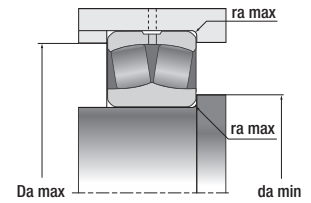
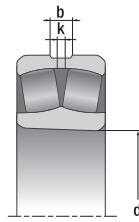
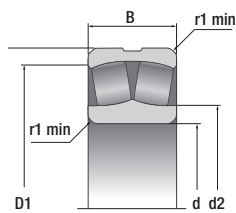

	Thermal reference speed	Limiting speed	Mass Cylindrical bore	Dimensions						Fitting dimensions		
	rpm		kg	Number of lubrication holes on the outer ring	b	k	r ₁ min	d ₂	D ₁	d _a min	D _a max	r _a max
					mm						mm	
	13000	17000	0,155	3 or 4	3	1,5	1	30,5	45,5	30,6	46,4	1
	14000	17000	0,16	3 or 4	3	1,5	1	30,5	45,5	30,6	46,4	1
		3900	0,21	3 or 4	3	1,5	1	28,6	47,7	28,6	47,7	1
	8800	14000	0,257	0	-	-	1,1	34,5	51,2	32	55	1
	11000	14000	0,272	3 or 4	4,4	2	1	37,5	54,3	35,6	56,4	1
	11000	14000	0,276	3 or 4	4,4	2	1	37,5	54,3	35,6	56,4	1
		3100	0,33	3 or 4	4,4	2	1	35,2	56,4	35,2	56,4	1
	7800	12000	0,394	0	-	-	1,1	40,8	59,7	37	65	1
	9500	12000	0,42	3 or 4	4,9	2	1,1	45,1	63	42	65	1
	9500	12000	0,44	3 or 4	4,9	2	1,1	45,1	63	42	65	1
		2600	0,51	3 or 4	4,9	2	1,1	42,8	65,1	42	65,1	1
	6900	10000	0,527	3 or 4	6,2	2,5	1,5	50,6	69	44	71	1,5
	8200	11000	0,515	3 or 4	5,4	2,5	1,1	50,2	70,8	47	73	1
	8200	11000	0,54	3 or 4	5,4	2,5	1,1	50,2	70,8	47	73	1
	8300	11000	0,5	3 or 4	5,4	2,5	1,1	50,2	70,8	47	73	1
		2300	0,62	3 or 4	5,4	2,5	1,1	47,8	73,9	47	73,9	1
	6400	9300	0,715	0	-	-	1,5	53,5	75,4	49	81	1,5
	5800	7400	1,006	3 or 4	5,9	3	1,5	52,5	77	49	81	1,5
	5800	7400	1,021	3 or 4	5,9	3	1,5	52,5	77	49	81	1,5
	5800	7400	1,021	3 or 4	5,9	3	1,5	52,5	77	49	81	1,5
	7400	9800	0,565	3 or 4	5,8	2,5	1,1	54,9	75,6	52	78	1
	7400	9800	0,59	3 or 4	5,8	2,5	1,1	54,9	75,6	52	78	1
	7500	9800	0,5	3 or 4	5,8	2,5	1,1	54,9	75,6	52	78	1
		2100	0,66	3 or 4	5,8	2,5	1,1	52,4	78,7	52	78,7	1
	5600	8300	0,95	3 or 4	6,84	3	1,5	65	86,7	54	91	1,5
	5300	6700	1,352	3 or 4	6,4	3	1,5	58	85,8	54	91	1,5
	5300	6700	1,369	3 or 4	6,4	3	1,5	58	85,8	54	91	1,5
	5300	6700	1,369	3 or 4	6,4	3	1,5	58	85,8	54	91	1,5
	6700	9100	0,603	3 or 4	5,8	2,5	1,1	59,5	80,7	57	83	1
	6700	9100	0,63	3 or 4	5,8	2,5	1,1	59,5	80,7	57	83	1
	6700	9100	0,585	3 or 4	5,8	2,5	1,1	59,5	80,7	57	83	1
		1900	0,7	3 or 4	5,8	2,5	1,1	57,1	82,2	57	83	1
		1900	0,7	3 or 4	5,8	2,5	1,1	57,1	82,2	57	83	1
	5400	7600	1,251	0	-	-	2	66,8	92,4	61	99	2
	4900	6100	1,81	3 or 4	7	3,5	2	63,8	93,2	61	99	2
	4900	6100	1,834	3 or 4	7	3,5	2	63,8	93,2	61	99	2
	4900	6100	1,834	3 or 4	7	3,5	2	63,8	93,2	61	99	2

SPHERICAL ROLLER BEARING REFERENCES

Overall dimensions			ULTAGE	Designations		Fatigue load limit	Dynamic load		Calculation factors			
d	D	B		Cylindrical bore	Tapered bore	C ₀	Dynamic C	Static C ₀	e	Y ₁	Y ₂	Y ₀
mm						kN						
55	100	25	*	22211EAW33	22211EAKW33	18,0	155	148	0,23	2,95	4,39	2,89
	100	25	*	22211EAW33ZZ	22211EAKW33ZZ	18,0	155	148	0,23	2,95	4,39	2,89
	100	25	*	22211EMW33	22211EMKW33	17,1	148	140	0,23	2,95	4,39	2,89
	100	31	*	10X22211EAW33EE	10X22211EAKW33EE	18,0	155	148	0,23	2,95	4,4	2,89
	100	31	*	10X22211EAW33EEL	10X22211EAKW33EEL	18,0	155	148	0,23	2,95	4,4	2,89
	120	29		21311V	21311VK	20,0	172	164	0,24	2,83	4,21	2,76
	120	43	*	22311EAW33	22311EAKW33	33,4	296	274	0,36	1,87	2,79	1,83
	120	43	*	22311EMW33	22311EMKW33	33,4	296	274	0,36	1,87	2,79	1,83
60	110	28	*	22212EAW33	22212EAKW33	22,1	187	181	0,24	2,84	4,23	2,78
	110	28	*	22212EAW33ZZ	22212EAKW33ZZ	22,1	187	181	0,24	2,84	4,23	2,78
	110	28	*	22212EMW33	22212EMKW33	20,9	179	171	0,24	2,84	4,23	2,78
	110	28	*	22212EF800	22212EKF800	20,9	179	171	0,24	2,84	4,23	2,78
	110	34	*	10X22212EAW33EE	10X22212EAKW33EE	22,1	187	181	0,24	2,84	4,23	2,78
	110	34	*	10X22212EAW33EEL	10X22212EAKW33EEL	22,1	187	181	0,24	2,84	4,23	2,78
	130	31		21312V	21312VK	22,7	192	186	0,24	2,82	4,19	2,75
	130	46	*	22312EAW33	22312EAKW33	38,9	340	319	0,35	1,95	2,9	1,91
65	120	31	*	22213EAW33	22213EAKW33	27,3	226	224	0,24	2,79	4,15	2,73
	120	31	*	22213EAW33ZZ	22213EAKW33ZZ	27,3	226	224	0,24	2,79	4,15	2,73
	120	31	*	22213EMW33	22213EMKW33	25,9	217	212	0,24	2,79	4,15	2,73
	120	38	*	10X22213EAW33EE	10X22213EAKW33EE	27,3	226	224	0,24	2,79	4,15	2,73
	120	38	*	10X22213EAW33EEL	10X22213EAKW33EEL	27,3	226	224	0,24	2,79	4,15	2,73
	140	33		21313V	21313VK	25,8	224	215	0,23	2,91	4,33	2,84
	140	48	*	22313EAW33	22313EAKW33	41,2	369	343	0,33	2,06	3,06	2,01
	140	48	*	22313EMW33	22313EMKW33	41,2	369	343	0,33	2,06	3,06	2,01
70	125	31	*	22214EAW33	22214EAKW33	29,3	235	240	0,22	3,01	4,48	2,94
	125	31	*	22214EMW33	22214EMKW33	29,3	235	240	0,22	3,01	4,48	2,94
	125	38	*	10X22214EAW33EE	10X22214EAKW33EE	29,3	235	240	0,22	3,01	4,48	2,94
	125	38	*	10X22214EAW33EEL	10X22214EAKW33EEL	29,3	235	240	0,22	3,01	4,48	2,94
	150	35		21314V	21314VK	28,3	246	240	0,23	2,9	4,31	2,83
	150	51	*	22314EAW33	22314EAKW33	46,7	420	396	0,34	2	2,98	1,96
	150	51	*	22314EMW33	22314EMKW33	46,7	420	396	0,34	2	2,98	1,96
	150	51	*	22314EF800	22314EKF800	46,7	420	396	0,34	2	2,98	1,96
75	130	31	*	22215EAW33	22215EAKW33	29,9	244	249	0,22	3,13	4,67	3,06
	130	31	*	22215EAW33ZZ	22215EAKW33ZZ	29,9	244	249	0,22	3,13	4,67	3,06
	130	31	*	22215EMW33	22215EMKW33	29,9	244	249	0,22	3,13	4,67	3,06
	130	38	*	10X22215EAW33EE	10X22215EAKW33EE	29,9	244	249	0,22	3,14	4,67	3,07
	130	38	*	10X22215EAW33EEL	10X22215EAKW33EEL	29,9	244	249	0,22	3,13	4,67	3,06
	160	37		21315V	21315VK	31,7	280	274	0,23	2,93	4,37	2,87
	160	55	*	22315EAW33	22315EAKW33	53,9	491	467	0,34	2	2,98	1,96
	160	55	*	22315EMW33	22315EMKW33	53,9	491	467	0,34	2	2,98	1,96
80	140	33	*	22216EAW33	22216EAKW33	33,8	278	287	0,22	3,14	4,67	3,07
	140	33	*	22216EAW33ZZ	22216EAKW33ZZ	33,8	278	287	0,22	3,14	4,67	3,07
	140	33	*	22216EMW33	22216EMKW33	32,0	267	272	0,22	3,13	4,67	3,06
	140	33	*	22216EF800	22216EKF800	32,0	267	272	0,22	3,13	4,67	3,06
	140	40	*	10X22216EAW33EE	10X22216EAKW33EE	33,8	278	287	0,22	3,14	4,67	3,07
	140	40	*	10X22216EAW33EEL	10X22216EAKW33EEL	33,8	278	287	0,22	3,14	4,67	3,07
	170	39		21316V	21316VK	33,6	300	296	0,23	2,95	4,39	2,89
	170	58	*	22316EAW33	22316EAKW33	59,1	541	522	0,34	2	2,98	1,96
170	58	*	22316EMW33	22316EMKW33	59,1	541	522	0,34	2	2,98	1,96	
170	58	*	22316EF800	22316EKF800	59,1	541	522	0,34	2	2,98	1,96	

Bearings available with cylindrical and tapered bores Bearings with tapered bores are generally fitted with adapter or withdrawal sleeves. All types of clearances are available from stock or on request. Special clearances and special precisions are available on request.

*NTN-SNR ULTAGE bearing

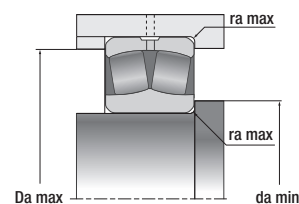
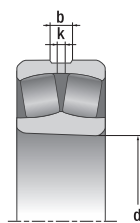
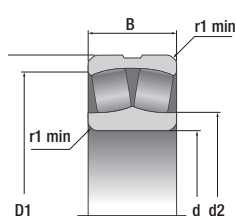

	Thermal reference speed	Limiting speed	Mass Cylindrical bore	Dimensions						Fitting dimensions		
	rpm		kg	Number of lubrication holes on the outer ring	b	k	r ₁ min	d ₂	D ₁	d _a min	D _a max	r _a max
					mm						mm	
	6100	8200	0,823	3 or 4	6,4	3	1,5	66	89,7	64	91	1,5
	6100	8200	0,85	3 or 4	6,4	3	1,5	66	89,7	64	91	1,5
	6100	8200	0,84	3 or 4	6,4	3	1,5	66	89,7	64	91	1,5
		1700	0,965	3 or 4	6,4	3	1,5	63,4	93,9	63,4	93,9	1,5
		1700	0,965	3 or 4	6,4	3	1,5	63,4	93,9	63,4	93,9	1,5
	5000	6900	1,537	0	-	-	2	73,6	102	66	109	2
	4600	5600	2,29	3 or 4	7,8	3,5	2	68,7	102,9	66	109	2
	4600	5600	2,34	3 or 4	7,8	3,5	2	68,7	102,9	66	109	2
	4600	5600	2,34	3 or 4	7,8	3,5	2	68,7	102,9	66	109	2
	5600	7500	1,134	3 or 4	6,9	3	1,5	71,9	98,5	69	101	1,5
	5600	7500	1,176	3 or 4	6,9	3	1,5	71,9	98,5	69	101	1,5
	5700	7500	1,147	3 or 4	6,9	3	1,5	71,9	98,5	69	101	1,5
	5700	7500	1,165	3 or 4	6,9	3	1,5	71,9	98,5	69	101	1,5
		1600	1,33	3 or 4	6,9	3	1,5	69,2	102,5	69	102,5	1,5
		1600	1,33	3 or 4	6,9	3	1,5	69,2	102,5	69	102,5	1,5
	4700	6400	1,986	0	-	-	2,1	79,5	109,9	72	118	2
	4300	5100	2,804	3 or 4	8,7	4	2,1	75,3	111,9	72	118	2
	4300	5100	2,892	3 or 4	8,7	4	2,1	75,3	111,9	72	118	2
	4300	5100	2,892	3 or 4	8,7	4	2,1	75,3	111,9	72	118	2
	5300	6900	1,512	3 or 4	7,8	3,5	1,5	78,2	107	74	111	1,5
	5300	6900	1,57	3 or 4	7,8	3,5	1,5	78,2	107	74	111	1,5
	5300	6900	1,589	3 or 4	7,8	3,5	1,5	78,2	107	74	111	1,5
		1500	1,908	3 or 4	7,8	3,5	1,5	75,3	116,4	74	116,5	1,5
		1500	1,93	3 or 4	7,8	3,5	1,5	75,3	116,4	74	111	1,5
	4400	5900	2,41	0	-	-	2,1	85,8	119,7	77	128	2
	4000	4800	3,413	3 or 4	9,2	4	2,1	81,3	121,2	77	128	2
	4000	4800	3,493	3 or 4	9,2	4	2,1	81,3	121,2	77	128	2
	4000	4800	3,493	3 or 4	9,2	4	2,1	81,3	121,2	77	128	2
	4900	6500	1,586	3 or 4	7,4	3,5	1,5	84,1	112,7	79	116	1,5
	4900	6500	1,52	3 or 4	7,4	3,5	1,5	84,1	112,7	79	116	1,5
		1400	1,89	3 or 4	7,4	3,5	1,5	81,2	117,1	79	117,1	1,5
		1400	1,89	3 or 4	7,4	3,5	1,5	81,2	117,1	79	117,1	1,5
	4200	5500	2,99	0	-	-	2,1	91,3	126,8	82	138	2
	3800	4500	4,176	3 or 4	10,4	5	2,1	86	128,7	82	138	2
	3800	4500	4,274	3 or 4	10,4	5	2,1	86	128,7	82	138	2
	3800	4500	4,274	3 or 4	10,4	5	2,1	86	128,7	82	138	2
	4600	6200	1,644	3 or 4	7,4	3,5	1,5	88,4	117,8	84	121	1,5
	4600	6200	1,72	3 or 4	7,4	3,5	1,5	88,4	117,8	84	121	1,5
	4600	6200	1,72	3 or 4	7,4	3,5	1,5	88,4	117,8	84	121	1,5
		1300	1,95	3 or 4	7,4	3,5	1,5	85,1	121,6	84	121,6	1,5
		1300	1,92	3 or 4	7,4	3,5	1,5	85,1	121,6	84	121	1,5
	4000	5200	3,59	0	-	-	2,1	97,7	136	87	148	2
	3600	4200	5,083	3 or 4	10,5	5	2,1	91,9	138,3	87	148	2
	3600	4200	5,21	3 or 4	10,5	5	2,1	91,9	138,3	87	148	2
	3600	4200	5,21	3 or 4	10,5	5	2,1	91,9	138,3	87	148	2
	4300	5800	2,071	3 or 4	7,87	3,5	2	94	127	91	129	2
	4300	5800	2,152	3 or 4	7,87	3,5	2	94	127	91	129	2
	4300	5800	2,157	3 or 4	7,9	3,5	2	94,9	126,7	91	129	2
	4300	5800	2,071	3 or 4	7,9	3,5	2	94,9	126,7	91	129	2
		1200	2,43	3 or 4	7,9	3,5	2	91,3	131,5	91	131,5	2
		1200	2,43	3 or 4	7,9	3,5	2	91,3	131,5	91	129	2
	3800	4900	4,26	0	-	-	2,1	104,3	144,6	92	158	2
	3400	3900	6,03	3 or 4	10,5	5	2,1	98,6	147,4	92	158	2
	3400	3900	6,2	3 or 4	10,5	5	2,1	98,6	147,4	92	158	2
	3400	3900	6,2	3 or 4	10,5	5	2,1	98,6	147,4	92	158	2

SPHERICAL ROLLER BEARING REFERENCES

Overall dimensions			ULTAGE	Designations		Fatigue load limit	Dynamic load		Calculation factors				
d	D	B		Cylindrical bore	Tapered bore	C _u	Dynamic C	Static C ₀	e	Y ₁	Y ₂	Y ₀	
mm						kN							
85	150	36	*	2221EAW33	2221EAKW33	38,0	324	330	0,22	3,07	4,58	3,01	
	150	36	*	2221EAW33ZZ	2221EAKW33ZZ	38,0	324	330	0,22	3,07	4,58	3,01	
	150	36	*	2221EMW33	2221EMKW33	38,0	324	330	0,22	3,07	4,58	3,01	
	150	44	*	10X22217EAW33EE	10X22217EAKW33EE	38,0	324	330	0,22	3,07	4,57	3	
	150	44	*	10X22217EAW33EEL	10X22217EAKW33EEL	38,0	324	330	0,22	3,07	4,57	3	
	180	41	*	21317VM	21317VKM	38,4	341	344	0,23	2,99	4,46	2,93	
	180	60	*	22317EAW33	22317EAKW33	67,0	599	604	0,32	2,09	3,11	2,04	
	180	60	*	22317EMW33	22317EMKW33	67,0	599	604	0,32	2,09	3,11	2,04	
	180	60	*	22317EF800	22317EFK800	67,0	599	604	0,32	2,09	3,11	2,04	
90	160	40	*	22218EAW33	22218EAKW33	45,2	384	398	0,23	2,9	4,31	2,83	
	160	40	*	22218EAW33ZZ	22218EAKW33ZZ	45,2	384	398	0,23	2,9	4,31	2,83	
	160	40	*	22218EMW33	22218EMKW33	45,2	384	398	0,23	2,9	4,31	2,83	
	160	40	*	22218EF800	22218EFK800	45,2	384	398	0,23	2,9	4,31	2,83	
	160	48	*	10X22218EAW33EE	10X22218EAKW33EE	45,2	384	398	0,23	2,9	4,31	2,83	
	160	48	*	10X22218EAW33EEL	10X22218EAKW33EEL	45,2	384	398	0,23	2,9	4,31	2,83	
	190	43	*	21318VM	21318VKM	41,3	370	377	0,22	3	4,47	2,93	
	190	64	*	22318EAW33	22318EAKW33	71,4	668	652	0,33	2,06	3,07	2,01	
	190	64	*	22318EMW33	22318EMKW33	71,4	668	652	0,33	2,06	3,07	2,01	
	190	64	*	22318EF800	22318EFK800	71,4	668	652	0,33	2,06	3,07	2,01	
	160	52,4	*	23218EAW33	23218EAKW33	58,3	467	513	0,3	2,25	3,34	2,2	
	160	52,4	*	23218EMW33	23218EMKW33	58,3	467	513	0,3	2,25	3,34	2,2	
	95	170	43	*	22219EAW33	22219EAKW33	46,5	416	417	0,23	2,95	4,4	2,89
		170	43	*	22219EMW33	22219EMKW33	46,5	416	417	0,23	2,95	4,4	2,89
		170	51	*	10X22219EAW33EE	10X22219EAKW33EE	46,5	416	417	0,23	2,95	4,4	2,89
200		45	*	21319D1	21319KD1	54,0	375	420	0,22	3,01	4,48	2,94	
200		67	*	22319EAW33	22319EAKW33	80,6	732	750	0,32	2,09	3,11	2,04	
200		67	*	22319EMW33	22319EMKW33	80,6	732	750	0,32	2,09	3,11	2,04	
200		67	*	22319EF800	22319EFK800	80,6	732	750	0,32	2,09	3,11	2,04	
100	150	50	*	24020EAW33	24020EAK30W33	54,4	361	479	0,29	2,35	3,5	2,3	
	165	52	*	23120EAW33	23120EAKW33	62,8	464	563	0,28	2,39	3,56	2,34	
	165	52	*	23120EMW33	23120EMKW33	64,1	471	575	0,28	2,39	3,56	2,34	
	180	46	*	22220EAW33	22220EAKW33	54,3	472	495	0,24	2,84	4,23	2,78	
	180	46	*	22220EAW33ZZ	22220EAKW33ZZ	54,3	472	495	0,24	2,84	4,23	2,78	
	180	46	*	22220EMW33	22220EMKW33	54,3	472	495	0,24	2,84	4,23	2,78	
	180	46	*	22220EF800	22220EFK800	54,3	472	495	0,24	2,84	4,23	2,78	
	180	55	*	10X22220EAW33EE	10X22220EAKW33EE	54,3	472	495	0,24	2,84	4,23	2,78	
	180	60,3	*	23220EAW33	23220EAKW33	72,3	586	661	0,31	2,18	3,24	2,13	
	180	60,3	*	23220EMW33	23220EMKW33	72,3	586	661	0,31	2,18	3,24	2,13	
	215	47	*	21320D1	21320KD1	42,5	410	465	0,22	3,01	4,48	2,94	
	215	73	*	22320EAW33	22320EAKW33	88,9	827	844	0,34	1,98	2,94	1,93	
	215	73	*	22320EMW33	22320EMKW33	88,9	827	844	0,34	1,98	2,94	1,93	
	215	73	*	22320EF800	22320EFK800	88,9	827	844	0,34	1,98	2,94	1,93	
	110	170	45	*	23022EAW33	23022EAKW33	56,7	417	517	0,23	2,95	4,4	2,89
170		45	*	23022EMW33	23022EMKW33	56,7	417	517	0,23	2,95	4,4	2,89	
170		60	*	24022EAW33	24022EAK30W33	72,9	518	663	0,31	2,15	3,2	2,1	
170		60	*	24022EMW33	24022EMK30W33	72,9	518	663	0,31	2,15	3,2	2,1	
180		56	*	23122EAW33	23122EAKW33	72,7	547	669	0,28	2,43	3,61	2,37	
180		56	*	23122EMW33	23122EMKW33	72,7	547	669	0,28	2,43	3,61	2,37	
180		69	*	24122EAW33	24122EAK30W33	83,7	622	769	0,36	1,9	2,83	1,86	
200		53	*	22222EAW33	22222EAKW33	68,4	602	643	0,25	2,69	4	2,63	
200		53	*	22222EMW33	22222EMKW33	68,4	602	643	0,25	2,69	4	2,63	
200		53	*	22222EF800	22222EFK800	68,4	602	643	0,25	2,69	4	2,63	
200		69,8	*	23222EAW33	23222EAKW33	92,3	752	869	0,32	2,12	3,15	2,07	
200		69,8	*	23222EMW33	23222EMKW33	92,3	752	869	0,32	2,12	3,15	2,07	
240		50	*	21322D1	21322KD1	61,5	550	615	0,21	3,2	4,77	3,13	
240		80	*	22322EAW33	22322EAKW33	99,4	975	972	0,32	2,09	3,11	2,04	
240		80	*	22322EMW33	22322EMKW33	99,4	975	972	0,32	2,09	3,11	2,04	
240		80	*	22322EF800	22322EFK800	99,4	975	972	0,32	2,09	3,11	2,04	

Bearings available with cylindrical and tapered bores. Bearings with tapered bores are generally fitted with adapter or withdrawal sleeves. All types of clearances are available from stock or on request. Special clearances and special precisions are available on request.
*NTN-SNR ULTAGE bearing

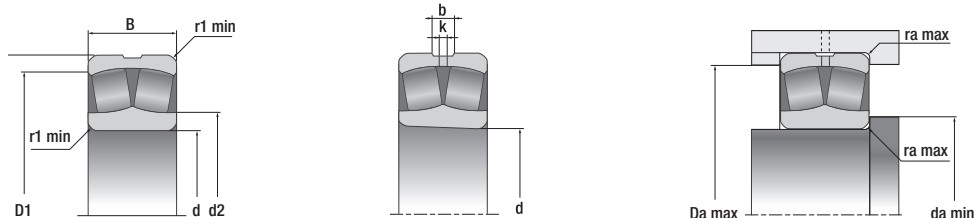

	Thermal reference speed	Limiting speed	Mass Cylindrical bore	Dimensions					Fitting dimensions			
	rpm	kg	Number of lubrication holes on the outer ring	b	k	r ₁ min	d ₂	D ₁	d _a min	D _a max	r _a max	
				mm					mm			
	4100	5400	2,56	3 or 4	7,9	3,5	2	100,7	136,5	96	139	2
	4100	5400	2,64	3 or 4	7,9	3,5	2	100,7	136,5	96	139	2
	4100	5400	2,6	3 or 4	7,9	3,5	2	100,7	136,5	96	139	2
		1100	2,99	3 or 4	7,9	3,5	2	97,2	140,8	96	140,8	2
		1100	2,99	3 or 4	7,9	3,5	2	97,2	140,8	96	140,8	2
	3600	4600	5,16	0	-	-	3	111	153,1	99	166	2,5
	3200	3600	7,061	3 or 4	11	5	3	107,9	156,7	99	166	2,5
	3200	3600	7,16	3 or 4	11	5	3	107,9	156,7	99	166	2,5
	3200	3600	7,16	3 or 4	11	5	3	107,9	156,7	99	166	2,5
	3900	5100	3,283	3 or 4	10,2	4,5	2	105,3	143,2	101	149	2
	3900	5100	3,39	3 or 4	10,2	4,5	2	105,3	143,2	101	149	2
	3900	5100	3,3	3 or 4	10,2	4,5	2	105,3	143,2	101	149	2
	3900	5100	3,283	3 or 4	10,2	4,5	2	105,3	143,2	101	149	2
		1100	3,71	3 or 4	10,2	4,5	2	101,9	147,4	101	149	2
		1100	3,71	3 or 4	10,2	4,5	2	101,9	147,4	101	149	2
	3400	4300	6,03	0	-	-	3	117,6	161,5	104	176	2,5
	3000	3500	8,285	3 or 4	11,6	5	3	110,1	165,1	104	176	2,5
	3000	3500	8,501	3 or 4	11,6	5	3	110,1	165,1	104	176	2,5
	3000	3500	8,501	3 or 4	11,6	5	3	110,1	165,1	104	176	2,5
	2900	3700	4,43	3 or 4	8,9	4	2	104,3	141	101	149	2
	2900	3700	4,42	3 or 4	8,9	4	2	104,3	141	101	149	2
	3800	4800	3,95	3 or 4	9,9	4,5	2,1	110,8	152,8	107	158	2
	3800	4800	4,09	3 or 4	9,9	4,5	2,1	110,8	152,8	107	158	2
		1000	4,45	3 or 4	9,93	4,5	2,1	107,3	156,4	107	158	2
			7,1	4	7	4	3	127	171	109	186	2,5
	2800	3300	9,82	3 or 4	12,1	6	3	120	174	109	186	2,5
	2800	3300	10,06	3 or 4	12,1	6	3	120	174	109	186	2,5
	2800	3300	10	3 or 4	12,1	6	3	120	174	109	186	2,5
	3000	4100	2,96	3 or 4	6,1	2,5	1,5	111,1	135,3	107	143	1,5
	3200	3900	4,34	3 or 4	8,4	4	2	114,7	146,9	111	154	2
	3200	3900	5	3 or 4	8,4	4	2	114,6	146,9	111	154	2
	3600	4600	4,815	3 or 4	11,2	5	2,1	118,2	160,8	112	168	2
	3600	4600	4,989	3 or 4	11,2	5	2,1	118,2	160,8	112	168	2
	3600	4600	4,76	3 or 4	11,2	5	2,1	118,2	160,8	112	168	2
	3600	4600	4,815	3 or 4	11,2	5	2,1	118,2	160,8	112	168	2
		1000	5,58	3 or 4	11,2	5	2,1	114,4	166,4	112	168	2
	2600	3300	6,4	3 or 4	9,4	4,5	2,1	118,2	158,9	112	168	2
	2600	3300	6,53	3 or 4	9,4	4,5	2,1	118,2	158,9	112	168	2
			8,89	4	9	5	3	133	179	114	201	2,5
	2600	3100	12,47	3 or 4	13,3	6	3	126,7	186,7	114	201	2,5
	2600	3100	12,776	3 or 4	13,3	6	3	126,7	186,7	114	201	2,5
	2600	3100	12,776	3 or 4	13,3	6	3	126,7	186,7	114	201	2,5
	3500	4200	3,55	3 or 4	7,8	3,5	2	123,8	154,6	118,8	161,2	2
	3500	4200	3,62	3 or 4	7,8	3,5	2	123,8	154,6	118,8	161,2	2
	2800	3700	4,8	3 or 4	7,2	3	2	120,5	151,6	118,8	161,2	2
	2800	3700	4,8	3 or 4	7,21	3	2	0	151,6	118,8	161,2	2
	3000	3500	5,48	3 or 4	8,9	4	2	125,3	160,9	121	169	2
	3000	3500	5,51	3 or 4	8,9	4	2	125,3	160,9	121	169	2
	2200	2900	6,68	3 or 4	8,4	4	2	121,7	157,2	121	169	2
	3300	4100	6,929	3 or 4	12,2	6	2,1	130,1	178,4	122	188	2
	3300	4100	7,224	3 or 4	12,2	6	2,1	130,1	178,4	122	188	2
	3300	4100	6,929	3 or 4	12,2	6	2,1	130,1	178,4	122	188	2
	2300	3000	9,25	3 or 4	10,5	5	2,1	130,2	175,8	122	188	2
	2300	3000	9,39	3 or 4	10,5	5	2,1	130,2	175,8	122	188	2
			11,2	4	9	5	3	146	203	124	226	2,5
	2300	2800	16,87	3 or 4	15,6	7	3	138,9	208,1	124	226	2,5
	2300	2800	17,406	3 or 4	15,6	7	3	138,9	208,1	124	226	2,5
	2300	2800	17,406	3 or 4	15,6	7	3	138,9	208,1	124	226	2,5

SPHERICAL ROLLER BEARING REFERENCES

Overall dimensions			ULTAGE	Designations		Fatigue load limit	Dynamic load		Calculation factors				
d	D	B		Cylindrical bore	Tapered bore		C ₀	Dynamic C	Static C ₀	e	Y ₁	Y ₂	Y ₀
mm						kN							
120	180	46	*	23024EAW33	23024EAKW33	62,0	446	577	0,22	3,14	4,67	3,07	
	180	46	*	23024EMW33	23024EMKW33	62,0	446	577	0,22	3,14	4,67	3,07	
	180	60	*	24024EAW33	24024EAK30W33	76,0	535	705	0,3	2,28	3,39	2,23	
	200	62	*	23124EAW33	23124EAKW33	86,3	663	820	0,28	2,43	3,61	2,37	
	200	62	*	23124EMW33	23124EMKW33	86,3	663	820	0,28	2,43	3,61	2,37	
	200	80	*	24124EAW33	24124EAK30W33	100,0	749	948	0,39	1,74	2,59	1,7	
	215	58	*	22224EAW33	22224EAKW33	78,2	688	753	0,25	2,74	4,08	2,68	
	215	58	*	22224EMW33	22224EMKW33	78,2	688	753	0,25	2,74	4,08	2,68	
	215	76	*	23224EAW33	23224EAKW33	104,0	857	998	0,32	2,09	3,11	2,04	
	215	76	*	23224EMW33	23224EMKW33	104,0	857	998	0,32	2,09	3,11	2,04	
	260	86	*	22324EAW33	22324EAKW33	127,0	1170	1280	0,32	2,09	3,11	2,04	
	260	86	*	22324EMW33	22324EMKW33	127,0	1170	1280	0,32	2,09	3,11	2,04	
	260	86	*	22324EF800	22324EKF800	127,0	1170	1280	0,32	2,09	3,11	2,04	
	130	200	52	*	23026EAW33	23026EAKW33	75,3	565	721	0,22	3,01	4,48	2,94
		200	52	*	23026EMW33	23026EMKW33	75,3	565	721	0,22	3,01	4,48	2,94
		200	69	*	24026EAW33	24026EAK30W33	95,1	684	909	0,31	2,18	3,25	2,13
210		64	*	23126EAW33	23126EAKW33	93,7	710	906	0,27	2,51	3,74	2,46	
210		64	*	23126EMW33	23126EMKW33	93,7	710	906	0,27	2,51	3,74	2,46	
210		80	*	24126EAW33	24126EAK30W33	111,0	795	1070	0,34	1,96	2,92	1,92	
230		64	*	22226EAW33	22226EAKW33	91,4	808	898	0,25	2,69	4	2,63	
230		64	*	22226EMW33	22226EMKW33	91,4	808	898	0,25	2,69	4	2,63	
230		80	*	23226EAW33	23226EAKW33	115,0	958	1130	0,32	2,12	3,15	2,07	
230		80	*	23226EMW33	23226EMKW33	115,0	958	1130	0,32	2,12	3,15	2,07	
280		93	*	22326EAW33	22326EAKW33	136,0	1330	1400	0,33	2,06	3,06	2,01	
280		93	*	22326EMW33	22326EMKW33	136,0	1330	1400	0,33	2,06	3,06	2,01	
280		93	*	22326EF800	22326EKF800	136,0	1330	1400	0,33	2,06	3,06	2,01	
140		210	53	*	23028EAW33	23028EAKW33	80,4	597	783	0,22	3,14	4,67	3,07
		210	53	*	23028EMW33	23028EMKW33	80,4	597	783	0,22	3,14	4,67	3,07
		210	69	*	24028EAW33	24028EAK30W33	98,6	704	958	0,28	2,39	3,56	2,34
	225	68	*	23128EAW33	23128EAKW33	104,0	802	1030	0,26	2,55	3,8	2,5	
	225	68	*	23128EMW33	23128EMKW33	104,0	802	1030	0,26	2,55	3,8	2,5	
	225	85	*	24128EAW33	24128EAK30W33	130,0	951	1280	0,34	1,98	2,94	1,93	
	250	68	*	22228EAW33	22228EAKW33	100	867	1010	0,25	2,74	4,08	2,68	
	250	68	*	22228EMW33	22228EMKW33	100	867	1010	0,25	2,74	4,08	2,68	
	250	88	*	23228EAW33	23228EAKW33	136,0	1140	1370	0,33	2,06	3,06	2,01	
	250	88	*	23228EMW33	23228EMKW33	136,0	1140	1370	0,33	2,06	3,06	2,01	
	300	102	*	22328EAW33	22328EAKW33	163,0	1540	1720	0,33	2,03	3,02	1,98	
	300	102	*	22328EMW33	22328EMKW33	163,0	1540	1720	0,33	2,03	3,02	1,98	
	300	102	*	22328EF800	22328EKF800	163,0	1540	1720	0,33	2,03	3,02	1,98	
	150	225	56	*	23030EAW33	23030EAKW33	89,7	660	893	0,21	3,2	4,77	3,13
		225	56	*	23030EMW33	23030EMKW33	89,7	660	893	0,21	3,2	4,77	3,13
		225	75	*	24030EAW33	24030EAK30W33	115,0	832	1140	0,3	2,25	3,34	2,2
250		80	*	23130EAW33	23130EAKW33	133	1060	1350	0,29	2,35	3,5	2,3	
250		80	*	23130EMW33	23130EMKW33	133	1060	1350	0,29	2,35	3,5	2,3	
250		100	*	24130EAW33	24130EAK30W33	138,0	1120	1400	0,38	1,78	2,66	1,74	
270		73	*	22230EAW33	22230EAKW33	118,0	1080	1220	0,25	2,74	4,08	2,68	
270		73	*	22230EMW33	22230EMKW33	118,0	1080	1220	0,25	2,74	4,08	2,68	
270		96	*	23230EAW33	23230EAKW33	157,0	1340	1620	0,33	2,03	3,02	1,98	
270		96	*	23230EMW33	23230EMKW33	157,0	1340	1620	0,33	2,03	3,02	1,98	
320		108	*	22330EAW33	22330EAKW33	177,0	1740	1890	0,34	2	2,98	1,96	
320		108	*	22330EMW33	22330EMKW33	177,0	1740	1890	0,34	2	2,98	1,96	
160		220	45	*	23932EMD1	23932EMKD1	45,6	455	683	0,17	3,9	5,81	3,81
		240	60	*	23032EAW33	23032EAKW33	98,6	748	1000	0,21	3,2	4,77	3,13
		240	60	*	23032EMW33	23032EMKW33	98,6	748	1000	0,21	3,2	4,77	3,13
		240	80	*	24032EAW33	24032EAK30W33	130,0	953	1320	0,29	2,32	3,45	2,26
	270	86	*	23132EAW33	23132EAKW33	152,0	1220	1580	0,29	2,35	3,5	2,3	
	270	86	*	23132EMW33	23132EMKW33	152,0	1220	1580	0,29	2,35	3,5	2,3	
	270	109	*	24132EAW33	24132EAK30W33	168,0	1330	1740	0,38	1,76	2,62	1,72	
	290	80	*	22232EAW33	22232EAKW33	132,0	1220	1390	0,25	2,69	4	2,63	
	290	80	*	22232EMW33	22232EMKW33	132,0	1220	1390	0,25	2,69	4	2,63	
	290	104	*	23232EAW33	23232EAKW33	180,0	1550	1890	0,33	2,03	3,02	1,98	
	290	104	*	23232EMW33	23232EMKW33	180,0	1550	1890	0,33	2,03	3,02	1,98	
	340	114	*	22332EAW33	22332EAKW33	202,0	1950	2210	0,33	2,03	3,02	1,98	
	340	114	*	22332EMW33	22332EMKW33	202,0	1950	2210	0,33	2,03	3,02	1,98	
	340	114	*	22332EF800	22332EKF800	202,0	1950	2210	0,33	2,03	3,02	1,98	

Bearings available with cylindrical and tapered bores Bearings with tapered bores are generally fitted with adapter or withdrawal sleeves. All types of clearances are available from stock or on request. Special clearances and special precisions are available on request.
*NTN-SNR ULTAGE bearing

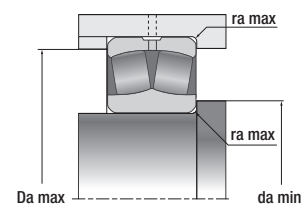
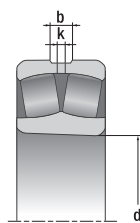
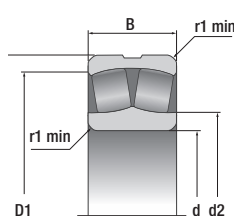

	Thermal reference speed	Limiting speed	Mass Cylindrical bore	Dimensions						Fitting dimensions		
	rpm	rpm	kg	Number of lubrication holes on the outer ring	b	k	r ₁ min	d ₂	D ₁	d _s min	D _s max	r _s max
					mm						mm	
	3300	3900	3,99	3 or 4	7,8	3,5	2	134	164,9	128,8	171,2	2
	3300	3900	3,99	3 or 4	7,8	3,5	2	134	164,9	128,8	171,2	2
	2500	3400	5,1	3 or 4	6,4	3,5	2	130,6	162,2	128,8	171,2	2
	2600	3200	7,67	3 or 4	10	4,5	2	138,9	178,4	131	189	2
	2600	3200	7,76	3 or 4	10	4,5	2	138,9	178,4	131	189	2
	2000	2600	10	3 or 4	10	4,5	2	133,2	171,8	131	189	2
	3000	3800	8,693	3 or 4	12,2	6	2,1	141,9	192,3	132	203	2
	3000	3800	8,78	3 or 4	12,2	6	2,1	141,9	192,3	132	203	2
	2100	2800	11,89	3 or 4	11	5	2,1	139,9	189	132	203	2
	2100	2800	11,624	3 or 4	11	5	2,1	139,9	189	132	203	2
	2000	2500	22,17	3 or 4	18	8	3	156,9	224	134	246	2,5
	2000	2500	22,6	3 or 4	18	8	3	156,9	224	134	246	2,5
	2000	2500	22,6	3 or 4	18	8	3	156,9	224	134	246	2,5
	3000	3600	5,81	3 or 4	8,9	4	2	146	182,6	138,8	191,2	2
	3000	3600	5,87	3 or 4	8,9	4	2	146	182,6	138,8	191,2	2
	2300	3100	7,5	3 or 4	8,34	4	2	143	178,6	138,8	191,2	2
	2400	3000	8,4	3 or 4	10	4,5	2	148,5	188,3	141	199	2
	2400	3000	8,5	3 or 4	10	4,5	2	148,5	188,3	141	199	2
	1800	2400	10,5	3 or 4	10,32	4,5	2	146	183,2	141	199	2
	2800	3600	10,771	3 or 4	13,2	6	3	151,4	205,4	144	216	2,5
	2800	3600	10,9	3 or 4	13,2	6	3	151,4	205,4	144	216	2,5
	1900	2600	13,64	3 or 4	11,6	5	3	150,7	202,7	144	216	2,5
	1900	2600	13,77	3 or 4	11,6	5	3	150,7	202,7	144	216	2,5
	1800	2400	26,917	3 or 4	18,9	9	4	164,7	243	147	263	3
	1800	2400	27,9	3 or 4	18,9	9	4	164,7	243	147	263	3
	1800	2400	27,9	3 or 4	18,9	9	4	164,7	243	147	263	3
	2800	3400	6,33	3 or 4	8,9	4	2	155,6	192,7	148,8	201,2	2
	2800	3400	6,44	3 or 4	8,9	4	2	155,6	192,7	148,8	201,2	2
	2100	2900	8,03	3 or 4	8,9	4	2	152,9	188,2	148,8	201,2	2
	2200	2800	10,9	3 or 4	10,5	5	2,1	159,3	202	152	213	2
	2200	2800	11,3	3 or 4	10,5	5	2,1	159,3	202	152	213	2
	1600	2300	12,77	3 or 4	10,05	4,5	2,1	156,2	197,6	152	213	2
	2500	3300	14,2	3 or 4	14,2	7	3	163,9	223,9	154	236	2,5
	2500	3300	14,4	3 or 4	14,2	7	3	163,9	223,9	154	236	2,5
	1700	2400	17,92	3 or 4	12,6	6	3	162,6	219,6	154	236	2,5
	1700	2400	18,215	3 or 4	12,6	6	3	162,6	219,6	154	236	2,5
	1600	2200	34,13	3 or 4	18,9	9	4	181,7	260,3	157	283	3
	1600	2200	34,903	3 or 4	18,9	9	4	181,7	260,3	157	283	3
	1600	2200	34,903	3 or 4	18,9	9	4	181,7	260,3	157	283	3
	2600	3100	7,62	3 or 4	10	4,5	2,1	168,5	206,6	160,2	214,8	2
	2600	3100	7,75	3 or 4	10	4,5	2,1	168,5	206,6	160,2	214,8	2
	1900	2700	10,04	3 or 4	8,9	4	2,1	162,9	202,8	160,2	214,8	2
	2000	2600	15,72	3 or 4	12,6	6	2,1	171,9	222,4	162	238	2
	2000	2600	15,72	3 or 4	12,6	6	2,1	171,9	222,4	162	238	2,1
	1600	2000	19,9	3 or 4	10,4	5	2,1	165,8	218,1	162	238	2
	2200	3000	17,8	3 or 4	15,3	7	3	177,3	241,1	164	256	2,5
	2200	3000	17,992	3 or 4	15,3	7	3	177,3	241,1	164	256	2,5
	1500	2200	23,52	3 or 4	13,7	6	3	174,6	236,6	164	256	2,5
	1500	2200	23,52	3 or 4	13,7	6	3	174,6	236,6	164	256	2,5
	1500	2100	41,96	3 or 8	19,9	9	4	201	278,3	167	303	3
	1500	2100	41,96	3 or 8	19,9	9	4	201	278,3	167	303	3
			5,09	3	9	4	2	175	205	169	211	2
	2400	2900	9,3	3 or 4	10,5	5	2,1	178,5	220,2	170,2	229,8	2
	2400	2900	9,58	3 or 4	10,5	5	2,1	178,5	220,2	170,2	229,8	2
	1800	2600	11,84	3 or 4	9,5	4,5	2,1	173,8	216,2	170,2	229,8	2
	1800	2400	20,12	3 or 4	13,7	6	2,1	185,7	239,8	172	258	2
	1800	2400	20,12	3 or 4	13,7	6	2,1	185,7	239,8	172	258	2
	1400	1900	25,6	3 or 4	11,7	5	2,1	180,8	234,9	172	258	2
	2000	2800	23	3 or 4	16,9	8	3	190	258,7	174	276	2,5
	2000	2800	23,2	3 or 4	16,9	8	3	190	258,7	174	276	2,5
	1400	2100	29,19	3 or 4	14,9	7	3	187,1	253,7	174	276	2,5
	1400	2100	29,58	3 or 4	14,9	7	3	187,1	253,7	174	276	2,5
	1400	1900	50,7	3 or 8	20,3	10	4	219	295,2	177	323	3
	1400	1900	50,7	3 or 8	20,3	10	4	219	295,2	177	323	3

SPHERICAL ROLLER BEARING REFERENCES

Overall dimensions			ULTRAGE	Designations		Fatigue load limit	Dynamic load		Calculation factors				
d	D	B		Cylindrical bore	Tapered bore	C ₀	Dynamic C	Static C ₀	e	Y ₁	Y ₂	Y ₀	
mm						kN							
170	230	45	*	23934EMD1	23934EMKD1	48,8	468	723	0,16	4,11	6,12	4,02	
	260	67	*	23034EAW33	23034EAKW33	120,0	914	1240	0,22	3,07	4,58	3,01	
	260	67	*	23034EMW33	23034EMKW33	120,0	914	1240	0,22	3,07	4,58	3,01	
	260	90	*	24034EAW33	24034EAK30W33	153,0	1120	1580	0,31	2,21	3,29	2,16	
	280	88	*	23134EAW33	23134EAKW33	162,0	1270	1700	0,28	2,39	3,56	2,34	
	280	88	*	23134EMW33	23134EMKW33	162,0	1270	1700	0,28	2,39	3,56	2,34	
	280	109	*	24134EAW33	24134EAK30W33	175,0	1370	1840	0,37	1,83	2,72	1,79	
	310	86	*	22234EMW33	22234EMKW33	150,0	1400	1610	0,26	2,6	3,87	2,54	
	310	110	*	23234EMW33	23234EMKW33	193,0	1700	2070	0,33	2,03	3,02	1,98	
	360	120	*	22334EMW33	22334EMKW33	236,0	2200	2630	0,32	2,09	3,11	2,04	
	360	120	*	22334EF800	22334EFK800	236,0	2200	2630	0,32	2,09	3,11	2,04	
	180	250	52	*	23936EMD1	23936EMKD1	57,2	573	869	0,17	3,9	5,81	3,81
280		74	*	23036EAW33	23036EAKW33	137,0	1080	1450	0,23	2,95	4,4	2,89	
280		74	*	23036EMW33	23036EMKW33	137,0	1080	1450	0,23	2,95	4,4	2,89	
280		100	*	24036EAW33	24036EAK30W33	173,0	1270	1830	0,31	2,21	3,29	2,16	
300		96	*	23136EAW33	23136EAKW33	183,0	1490	1960	0,29	2,32	3,45	2,26	
300		96	*	23136EMW33	23136EMKW33	183,0	1490	1960	0,29	2,32	3,45	2,26	
300		118	*	24136EAW33	24136EAK30W33	192,0	1550	2050	0,38	1,78	2,66	1,74	
320		86	*	22236EMW33	22236EMKW33	153,0	1450	1660	0,25	2,74	4,08	2,68	
320		112	*	23236EF800	23236EFK800	209,0	1800	2270	0,33	2,06	3,06	2,01	
320		112	*	23236EMW33	23236EMKW33	209,0	1800	2270	0,33	2,06	3,06	2,01	
380		126	*	22336EF800	22336EFK800	249,0	2420	2810	0,32	2,09	3,11	2,04	
380		126	*	22336EMW33	22336EMKW33	249,0	2420	2810	0,32	2,09	3,11	2,04	
190	260	52	*	23938EMD1	23938EMKD1	62,8	603	935	0,17	4,05	6,04	3,96	
	290	75	*	23038EAW33	23038EAKW33	147,0	1140	1570	0,22	3,01	4,48	2,94	
	290	75	*	23038EMW33	23038EMKW33	147,0	1140	1570	0,22	3,01	4,48	2,94	
	290	100	*	24038EMW33	24038EMK30W33	169,0	1310	1800	0,31	2,15	3,2	2,1	
	320	104	*	23138EMW33	23138EMKW33	206,0	1670	2250	0,29	2,32	3,45	2,26	
	320	128	*	24138EAW33	24138EAK30W33	228,0	1850	2480	0,38	1,76	2,62	1,72	
	340	92	*	22238EMW33	22238EMKW33	169,0	1620	1870	0,25	2,74	4,08	2,68	
	340	120	*	23238EMW33	23238EMKW33	225,0	1990	2480	0,33	2,03	3,02	1,98	
	400	132	*	22338EF800	22338EFK800	272,0	2600	3120	0,32	2,12	3,15	2,07	
	400	132	*	22338EMW33	22338EMKW33	272,0	2600	3120	0,32	2,12	3,15	2,07	
	200	280	60	*	23940EMD1	23940EMKD1	71,8	766	1190	0,18	3,76	5,59	3,67
		310	82	*	23040EAW33	23040EAKW33	164	1310	1790	0,23	2,95	4,4	2,89
310		82	*	23040EMW33	23040EMKW33	164	1310	1790	0,23	2,95	4,4	2,89	
310		109	*	24040EMW33	24040EMK30W33	195	1520	2120	0,33	2,06	3,07	2,01	
340		112	*	23140EMW33	23140EMKW33	226	1890	2510	0,3	2,25	3,34	2,2	
340		140	*	24140EMW33	24140EMK30W33	265	2130	2930	0,39	1,74	2,59	1,7	
360		98	*	22240EMW33	22240EMKW33	187	1810	2100	0,25	2,74	4,08	2,68	
360		128	*	23240EMW33	23240EMKW33	253	2250	2840	0,34	1,98	2,94	1,93	
420		138	*	22340EF800	22340EFK800	302	2830	3530	0,31	2,15	3,2	2,1	
420		138	*	22340EMW33	22340EMKW33	302	2830	3530	0,31	2,15	3,2	2,1	
220		300	60	*	23944EMW33	23944EMKW33	111	741	1210	0,18	3,76	5,59	3,67
		340	90	*	23044EMW33	23044EMKW33	188	1530	2110	0,23	2,95	4,4	2,89
	340	118	*	24044EAW33	24044EAK30W33	246	1930	2750	0,31	2,18	3,25	2,13	
	340	118	*	24044EMW33	24044EMK30W33	246	1930	2750	0,31	2,18	3,25	2,13	
	370	120	*	23144EMW33	23144EMKW33	258	2190	2940	0,3	2,28	3,39	2,23	
	370	150	*	24144EMW33	24144EMK30W33	311	2600	3540	0,39	1,74	2,59	1,7	
	400	108	*	22244EMW33	22244EMKW33	232	2210	2690	0,25	2,74	4,08	2,68	
	400	144	*	23244EMW33	23244EMKW33	330	2890	3830	0,34	2	2,98	1,96	
	460	145	*	22344EMD1	22344EMKD1	163	3010	3560	0,32	2,1	3,13	2,06	
	240	320	60	*	23948EMD1	23948EMKD1	87,7	815	1350	0,15	4,4	6,56	4,31
360		92	*	23048EMW33	23048EMKW33	205	1630	2350	0,22	3,07	4,58	3,01	
360		118	*	24048EMW33	24048EMK30W33	267	2020	3050	0,29	2,32	3,45	2,26	
400		128	*	23148EMW33	23148EMKW33	299	2510	3500	0,29	2,32	3,45	2,26	
400		160	*	24148EAW33	24148EAK30W33	342	2860	3990	0,35	1,92	2,86	1,88	
440		120	*	22248EMD1	22248EMKD1	159	2470	3110	0,27	2,53	3,77	2,47	
440		160	*	23248EMD1	23248EMKD1	156	3140	4260	0,36	1,86	2,77	1,82	
500		155	*	22348EMD1	22348EMKD1	193	3500	4170	0,32	2,12	3,15	2,07	

Bearings available with cylindrical and tapered bores Bearings with tapered bores are generally fitted with adapter or withdrawal sleeves. All types of clearances are available from stock or on request. Special clearances and special precisions are available on request.
*NTN-SNR ULTRAGE bearing

	Thermal reference speed	Limiting speed	Mass Cylindrical bore	Dimensions						Fitting dimensions		
	rpm		kg	Number of lubrication holes on the orter ring	b	k	r ₁ min	d ₂	D ₁	d _a min	D _a max	r _a max
					mm						mm	
			5,39	4	9	4,5	2	185	215	179	221	2
	2200	2700	13	3 or 4	11,6	5	2,1	191,8	237,4	180,2	249,8	2
	2200	2700	13	3 or 4	11,6	5	2,1	191,8	237,4	180,2	249,8	2
	1600	2400	16,73	3 or 4	10,67	5	2,1	188	232,3	180,2	249,8	2
	1700	2300	21,55	3 or 4	13,7	6	2,1	196,2	249,7	182	268	2
	1700	2300	21,55	3 or 4	13,7	6	2,1	196,2	249,7	182	268	2
	1300	1800	26,6	3 or 4	13,2	6	2,1	189,5	243,6	182	268	2
	1900	2700	28,177	3 or 4	18	8	4	211,3	276,4	187	293	3
	1300	1900	35,7	3 or 4	16,35	8	4	210,4	271,2	187	293	3
	1200	1800	59	3 or 8	20,3	10	4	236	312,9	187	343	3
	1200	1800	59	3 or 8	20,3	10	4	236	312,9	187	343	3
			7,79	4	10	5	2	199	232	189	241	2
	2000	2500	16,9	3 or 4	13,2	6	2,1	203,6	255	190,2	269,8	2
	2000	2500	16,9	3 or 4	13,2	6	2,1	203,6	255	190,2	269,8	2
	1500	2200	21,5	3 or 4	11,8	5	2,1	202,5	249	190,2	269,8	2
	1600	2100	27,21	3 or 4	14,9	7	3	206	266,8	194	286	2,5
	1600	2100	27,21	3 or 4	14,9	7	3	206	266,8	194	286	2,5
	1200	1700	33,9	3 or 4	14,1	6	3	200,8	260,4	194	286	2,5
	1800	2600	28,941	3 or 8	18	8	4	220,2	286,8	197	303	3
	1200	1900	37,8	3 or 8	16,4	8	4	220	281,2	197	303	3
	1200	1900	37,8	3 or 8	16,4	8	4	210	281,2	197	303	3
	1200	1700	70,2	3 or 8	20,9	10	4	241,8	328,2	197	363	3
	1200	1700	70,2	3 or 8	20,9	10	4	241,8	328,2	197	363	3
			8,2	4	10	5	2	209	243	199	251	2
	1900	2400	17,47	3 or 4	13,2	6	2,1	213,4	265,1	200,2	279,8	2
	1900	2400	17,97	3 or 4	13,2	6	2,1	213,4	265,1	200,2	279,8	2
	1500	2100	22,53	3 or 4	11,6	5	2,1	216,2	260,1	200,2	279,8	2
	1500	2000	33,5	3 or 8	16,55	8	3	230	283,8	204	306	2,5
	1100	1600	42,1	3 or 8	14,2	6	3	213	277,9	204	306	2,5
	1600	2400	35,314	3 or 8	19,6	9	4	232,8	304,8	207	323	3
	1200	1800	46	3 or 8	17,5	8	4	220,8	298,1	207	323	3
	1100	1600	76,2	3 or 8	20,8	10	5	262,2	345,6	210	380	4
	1100	1600	81,6	3 or 8	20,8	10	5	262,2	345,6	210	380	4
			12	4	12	6	2,1	221	260	210	269	2
	1800	2300	22,5	3 or 4	14,28	7	2,1	227,3	282,3	210,2	299,8	2
	1800	2300	24,1	3 or 4	14,3	7	2,1	234,9	282,3	210,2	299,8	2
	1400	2000	29,2	3 or 4	12,7	6	2,1	229,7	283,3	210,2	299,8	2
	1400	1900	41,7	3 or 8	17,7	8	3	242	305,8	214	326	2,5
	1000	1500	51,3	3 or 8	17	8	3	236,8	291	214	326	2,5
	1500	2300	42,528	3 or 8	20	10	4	245,6	322,3	217	343	3
	1100	1700	55,8	3 or 8	18,8	9	4	244,8	314,8	217	343	3
	1000	1500	95	8	21,1	10	5	280	363,1	220	400	4
	1000	1500	95	8	21,1	10	5	280	363,1	220	400	4
	1800	2200	12,4	3 or 4	13,7	6	2,1	247,7	277,5	230,2	289,8	2
	1600	2100	31,8	3 or 8	15,4	7	3	258,1	310	232,4	327,6	2,5
	1200	1800	37,8	3 or 8	14,1	6	3	250,2	303,4	232,4	327,6	2,5
	1200	1800	38,4	3 or 8	14,1	6	3	0	303,4	232,4	327,6	2,5
	1200	1700	52,21	3 or 8	19,1	9	4	263	327,9	237	353	3
	850	1400	63,5	3 or 8	15,9	7	4	255,6	320,3	237	353	3
	1300	2000	59,474	3 or 8	20,6	11	4	276,3	357,7	237	383	3
	850	1500	77,2	3 or 8	20	10	4	276,3	348,5	237	383	3
			119	8	20	12	5	277	388	240	440	5
			13,5	4	12	6	2,1	262	301	250	309	2
	1400	2000	32,7	3 or 8	16,4	8	3	276,7	328,9	252,4	347,6	2,5
	1100	1700	41,6	3 or 8	15,3	7	3	262	323	252,4	347,6	2,5
	1100	1600	64,72	3 or 8	19,6	9	4	288	355,3	257	383	3
	800	1300	76,7	3 or 8	19,37	12	4	269	348,1	257	383	3
			82,6	8	16	10	4	288	383	257	423	4
			108	8	20	12	4	284	372	257	423	4
			149	8	20	12	5	299	421	260	480	5

SPHERICAL ROLLER BEARING REFERENCES

Overall dimensions			ULTAGE	Designations		Fatigue load limit	Dynamic load		Calculation factors			
d	D	B		Cylindrical bore	Tapered bore	C ₀	Dynamic C	Static C ₀	e	Y ₁	Y ₂	Y ₀
mm						kN						
260	360	75	*	23952EMD1	23952EMKD1	105	1130	1940	0,17	3,9	5,81	3,81
	400	104	*	23052EMW33	23052EMKW33	247	2060	2910	0,23	2,95	4,4	2,89
	400	140	*	24052EAW33	24052EAK30W33	325	2520	3820	0,31	2,16	3,22	2,12
	440	144	*	23152EMD1	23152EMKD1	160	2780	4020	0,31	2,15	3,2	2,1
	440	180	*	24152EMD1	24152EMK30D1	147	3290	4880	0,4	1,69	2,52	1,65
	480	130	*	22252EMD1	22252EMKD1	183	2890	3680	0,27	2,53	3,77	2,47
	480	174	*	23252EMD1	23252EMKD1	180	3650	5050	0,36	1,87	2,79	1,83
	540	165	*	22352EMD1	22352EMKD1	221	4020	4830	0,31	2,16	3,22	2,12
280	380	75	*	23956EMD1	23956EMKD1	115	1180	2050	0,16	4,16	6,2	4,07
	420	106	*	23056EMW33	23056EMKW33	263	2170	3150	0,22	3,07	4,58	3
	420	140	*	24056EMW33	24056EMK30W33	344	2720	4120	0,3	2,25	3,34	2,2
	460	146	*	23156EMD1	23156EMKD1	182	2980	4400	0,3	2,23	3,32	2,18
	460	180	*	24156EMD1	24156EMK30D1	167	3550	5450	0,38	1,78	2,65	1,74
	500	130	*	22256EMD1	22256EMKD1	198	3010	3920	0,25	2,69	4	2,63
	500	176	*	23256EMD1	23256EMKD1	193	3810	5420	0,35	1,95	2,9	1,91
	580	175	*	22356EMD1	22356EMKD1	249	4490	5450	0,31	2,18	3,24	2,13
300	420	90	*	23960EMD1	23960EMKD1	145	1600	2620	0,2	3,42	5,09	3,34
	460	118	*	23060EMD1	23060EMKD1	176	2400	3610	0,24	2,81	4,19	2,75
	460	160	*	24060EMD1	24060EMK30D1	166	3150	5190	0,33	2,04	3,04	2
	500	160	*	23160EMD1	23160EMKD1	205	3540	5170	0,31	2,2	3,27	2,15
	500	200	*	24160EMD1	24160EMK30D1	198	4270	6610	0,39	1,74	2,59	1,7
	540	140	*	22260EMD1	22260EMKD1	232	3470	4590	0,25	2,69	4	2,63
	540	192	*	23260EMD1	23260EMKD1	228	4520	6280	0,35	1,92	2,86	1,88
	620	385	*	22360BL1	22360BL1K	490	4000	5400	0,32	2,13	3,17	2,08
320	440	90	*	23964EMD1	23964EMKD1	154	1670	2820	0,19	3,62	5,39	3,54
	480	121	*	23064EMD1	23064EMKD1	191	2540	4020	0,23	2,92	4,35	2,86
	480	160	*	24064EMD1	24064EMK30D1	184	3250	5400	0,31	2,15	3,2	2,1
	540	176	*	23164EMD1	23164EMKD1	227	4020	6020	0,31	2,15	3,2	2,1
	540	218	*	24164EMD1	24164EMK30D1	225	5010	7720	0,39	1,71	2,54	1,67
	580	150	*	22264EMD1	22264EMKD1	261	3950	5100	0,25	2,69	4	2,63
	580	208	*	23264EMD1	23264EMKD1	259	5230	7370	0,35	1,91	2,85	1,87
340	460	90	*	23968EMD1	23968EMKD1	162	1710	2980	0,18	3,8	5,66	3,72
	520	133	*	23068EMD1	23068EMKD1	219	2990	4690	0,24	2,87	4,27	2,8
	520	180	*	24068EMD1	24068EMK30D1	206	3910	6510	0,33	2,06	3,06	2,01
	580	190	*	23168EMD1	23168EMKD1	257	4670	6870	0,32	2,12	3,15	2,07
	580	243	*	24168EMD1	24168EMK30D1	254	5980	9340	0,41	1,65	2,46	1,61
	620	224		23268B	23268BK	585	4950	8000	0,37	1,84	2,75	1,8
	620	224		23268BL1	23268BL1K	585	4950	8000	0,37	1,84	2,75	1,8
360	480	90	*	23972EMD1	23972EMKD1	171	1750	3090	0,17	4	5,96	3,91
	540	134	*	23072EMD1	23072EMKD1	232	3070	4910	0,23	2,98	4,44	2,92
	540	180	*	24072EMD1	24072EMK30D1	220	4040	6840	0,31	2,16	3,22	2,12
	600	192		23172B	23172BK	530	4200	7050	0,32	2,11	3,15	2,07
	600	192		23172BL1	23172BL1K	530	4200	7050	0,32	2,11	3,15	2,07
	600	243		24172B	24172BK30	470	5100	9150	0,4	1,67	2,48	1,63
	600	243		24172BL1	24172BL1K30	470	5100	9150	0,4	1,67	2,48	1,63
	650	232		23272B	23272BK	620	5400	8700	0,36	1,87	2,78	1,83
	650	232		23272BL1	23272BL1K	620	5400	8700	0,36	1,87	2,78	1,83
	380	520	106	*	23976EMD1	23976EMKD1	205	2300	3920	0,18	3,66	5,46
560		135	*	23076EMD1	23076EMKD1	247	3230	5270	0,22	3,07	4,57	3
560		180	*	24076EMD1	24076EMK30D1	240	4140	7280	0,3	2,25	3,34	2,2
620		194		23176B	23176BK	560	4350	7500	0,31	2,16	3,22	2,12
620		194		23176BL1	23176BL1K	560	4350	7500	0,31	2,16	3,22	2,12
620		243		24176B	24176BK30	570	5350	9650	0,39	1,73	2,58	1,69
620		243		24176BL1	24176BL1K30	570	5350	9650	0,39	1,73	2,58	1,69
680		240		23276B	23276BK	665	5800	9650	0,36	1,89	2,82	1,85
680		240		23276BL1	23276BL1K	665	5800	9650	0,36	1,89	2,82	1,85
400		540	106	*	23980EMD1	23980EMKD1	215	2370	4170	0,18	3,8	5,66
	600	148		23080B	23080BK	450	3300	6050	0,24	2,8	4,16	2,73
	600	148		23080BL1	23080BL1K	450	3300	6050	0,24	2,8	4,16	2,73
	600	200		24080B	24080BK30	485	4250	8400	0,32	2,09	3,11	2,04
	650	200		23180B	23180BK	630	4650	8050	0,31	2,21	3,29	2,16
	650	200		23180BL1	23180BL1K	630	4650	8050	0,31	2,21	3,29	2,16
	650	250		24180B	24180BK30	585	5650	10300	0,38	1,77	2,63	1,73
	720	256		23280B	23280BK	740	6500	10600	0,37	1,81	2,69	1,77

Bearings available with cylindrical and tapered bores. Bearings with tapered bores are generally fitted with adapter or withdrawal sleeves. All types of clearances are available from stock or on request. Special clearances and special precisions are available on request.
*NTN-SNR ULTAGE bearing

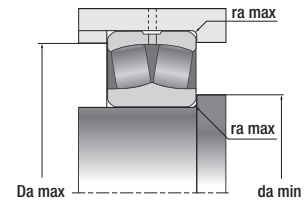
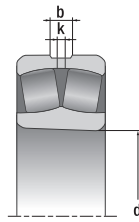
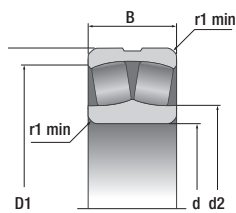

	Thermal reference speed	Limiting speed	Mass Cylindrical bore	Dimensions						Fitting dimensions		
	rpm		kg	Number of lubrication holes on the outer ring	b	k	r ₁ min	d ₂	D ₁	d _a min	D _a max	r _a max
					mm						mm	
			23,9	8	14	7	2,1	292	335	270	349	2
	1300	1800	47,28	3 or 8	18,3	8	4	301,5	365,1	274,6	385,4	3
	950	1600	62,42	3 or 8	19,3	8	4	286,2	353,9	275	385	3
			92,2	8	20	12	4	302	380	277	423	4
			111	8	27	16	4	295	371	277	423	4
			108	8	20	12	5	312	415	280	460	5
			143	8	27	16	5	310	405	280	460	5
			186	8	27	16	6	324	456	286	514	6
			25,2	8	14	7	2,1	310	356	290	369	2
	1200	1700	51,2	8	18,3	8	4	310	385,2	294,6	405,4	3
	900	1500	66	8	16,4	8	4	0	377,4	294,6	405,4	3
			98,4	8	20	12	5	322	403	300	440	5
			118	8	27	16	5	316	394	300	440	5
			113	8	20	12	5	333	437	300	480	5
			152	8	27	16	5	331	426	300	480	5
			228	8	27	16	6	349	489	306	554	6
			40,1	8	14	8	3	329	387	313	407	3
			72,9	8	16	10	4	338	413	315	445	4
			98	8	20	12	4	332	401	315	445	4
			129	8	20	12	5	345	436	320	480	5
			159	8	27	16	5	340	425	320	480	5
			134	8	20	12	5	358	469	320	520	5
			194	8	27	16	5	352	461	320	520	5
			270	8	27	16	7,5	381	522	336	584	6
			42,1	8	14	8	3	350	407	333	427	3
			78,9	8	20	12	4	360	433	335	465	4
			104	8	20	12	4	352	423	335	465	4
			169	8	27	16	5	373	468	340	520	5
			204	8	33	20	5	363	457	340	520	5
			177	8	20	12	5	383	510	340	560	5
			245	8	33	20	5	376	493	340	560	5
			44,5	8	14	8	3	370	427	353	447	3
			98,5	8	20	12	5	384	466	358	502	5
			140	8	27	16	5	377	456	358	502	5
			213	8	27	16	5	393	500	360	560	5
			266	8	33	20	5	385	486	360	560	5
			300	8	33	20	6	435	598	368	592	5
			300	8	33	20	6	435	598	368	592	5
			46,2	4	14	8	3	390	447	373	467	3
			111	8	20	12	5	405	488	378	522	5
			147	8	27	16	5	398	478	378	522	5
			222	8	27	16	5	417	520	382	578	4
			222	8	27	16	5	417	520	382	578	4
			281	8	33	20	5	414	507	382	578	4
			281	8	33	20	5	414	507	382	578	4
			339	8	33	20	6	429	551	388	622	5
			339	8	33	20	6	429	551	388	622	5
			68	8	16	10	4	412	481	395	505	4
			117	8	20	12	5	425	509	398	542	5
			154	8	27	16	5	420	499	398	542	5
			235	8	27	16	5	436	540	402	598	4
			235	8	27	16	5	436	540	402	598	4
			292	8	33	20	5	431	529	402	598	4
			292	8	33	20	5	431	529	402	598	4
			380	8	33	20	6	453	575	408	652	5
			380	8	33	20	6	453	575	408	652	5
			71,4	8	16	10	4	433	501	415	525	4
			149	8	20	12	5	451	542	422	578	4
			149	8	20	12	5	451	542	422	578	4
			202	8	27	16	5	446	528	422	578	4
			264	8	27	16	6	458	567	428	622	5
			264	8	27	16	6	458	567	428	622	5
			329	8	33	20	6	453	552	428	622	5
			457	8	33	20	6	473	612	428	692	5

SPHERICAL ROLLER BEARING REFERENCES

Overall dimensions			ULTAGE	Designations		Fatigue load limit	Dynamic load		Calculation factors				
d	D	B		Cylindrical bore	Tapered bore	C ₀	Dynamic C	Static C ₀	e	Y ₁	Y ₂	Y ₀	
mm						kN							
420	560	106	*	23984EMD1	23984EMKD1	230	2390	4320	0,17	3,95	5,88	3,86	
	620	150		23084B	23084BK	475	3450	6400	0,24	2,85	4,24	2,79	
	620	150		23084BL1	23084BL1K	475	3450	6400	0,24	2,85	4,24	2,79	
	620	200		24084B	24084BK30	470	4300	8450	0,32	2,13	3,17	2,08	
	620	200		24084BL1	24084BL1K30	470	4300	8450	0,32	2,13	3,17	2,08	
	700	224		23184B	23184BK	680	5800	9950	0,32	2,11	3,15	2,07	
	700	280		24184B	24184BK30	755	6850	12200	0,4	1,69	2,51	1,65	
	700	280		24184BL1	24184BL1K30	755	6850	12200	0,4	1,69	2,51	1,65	
	760	272		23284B	23284BK	820	7300	12000	0,36	1,86	2,77	1,82	
440	600	118		23988	23988K	325	2260	4700	0,18	3,66	5,46	3,58	
	650	157		23088B	23088BK	530	3650	6850	0,24	2,85	4,24	2,79	
	650	157		23088BL1	23088BL1K	530	3650	6850	0,24	2,85	4,24	2,79	
	650	212		24088B	24088BK30	530	4800	9450	0,32	2,11	3,15	2,07	
	650	212		24088BL1	24088BL1K30	530	4800	9450	0,32	2,11	3,15	2,07	
	720	226		23188B	23188BK	685	5800	10100	0,31	2,15	3,21	2,11	
	720	226		23188BL1	23188BL1K	685	5800	10100	0,31	2,15	3,21	2,11	
	720	280		24188B	24188BK30	715	7200	13100	0,39	1,75	2,61	1,71	
	720	280		24188BL1	24188BL1K30	715	7200	13100	0,39	1,75	2,61	1,71	
	790	280		23288B	23288BK	870	7700	12800	0,36	1,88	2,8	1,84	
	790	280		23288BL1	23288BL1K	870	7700	12800	0,36	1,88	2,8	1,84	
460	620	118		23992	23992K	325	2340	4950	0,17	3,95	5,88	3,86	
	680	163		23092B	23092BK	560	4000	7450	0,23	2,88	4,29	2,82	
	680	163		23092BL1	23092BL1K	560	4000	7450	0,23	2,88	4,29	2,82	
	680	218		24092B	24092BK30	590	5100	10200	0,31	2,15	3,21	2,11	
	760	240		23192B	23192BK	775	6350	11400	0,31	2,14	3,19	2,1	
	760	240		23192BL1	23192BL1K	775	6350	11400	0,31	2,14	3,19	2,1	
	760	300		24192BL1	24192BL1K30	805	7900	14500	0,39	1,71	2,55	1,67	
	830	296		23292BL1	23292BL1K	925	8650	14500	0,36	1,87	2,78	1,83	
	480	650	128		23996	23996K	365	2590	5500	0,18	3,85	5,73	3,76
650		128		23996L1	23996L1K	365	2590	5500	0,18	3,85	5,73	3,76	
700		165		23096B	23096BK	570	4050	7700	0,23	2,94	4,38	2,88	
700		165		23096BL1	23096BL1K	570	4050	7700	0,23	2,94	4,38	2,88	
700		218		24096B	24096BK30	610	5200	10500	0,3	2,22	3,3	2,17	
700		218		24096BL1	24096BL1K30	610	5200	10500	0,3	2,22	3,3	2,17	
790		248		23196B	23196BK	860	6900	12300	0,31	2,15	3,21	2,11	
790		248		23196BL1	23196BL1K	860	6900	12300	0,31	2,15	3,21	2,11	
790		308		24196B	24196BK30	860	8250	15300	0,39	1,74	2,59	1,7	
790		308		24196BL1	24196BL1K30	860	8250	15300	0,39	1,74	2,59	1,7	
870		310		23296B	23296BK	1000	9200	15500	0,36	1,87	2,78	1,83	
870		310		23296BL1	23296BL1K	1000	9200	15500	0,36	1,87	2,78	1,83	
500		670	128		239/500	239/500K	460	2640	5600	0,17	4,02	5,98	3,93
		670	128		239/500L1	239/500L1K	460	2640	5600	0,17	4,02	5,98	3,93
	720	167		230/500B	230/500BK	645	4250	8300	0,23	2,98	4,44	2,92	
	720	167		230/500BL1	230/500BL1K	645	4250	8300	0,23	2,98	4,44	2,92	
	720	218		240/500B	240/500BK30	640	5300	10900	0,3	2,28	3,4	2,23	
	720	218		240/500BL1	240/500BL1K30	640	5300	10900	0,3	2,28	3,4	2,23	
	830	264		231/500BL1	231/500BL1K	875	7790	13700	0,32	2,12	3,16	2,08	
	830	325		241/500BL1	241/500BL1K30	870	9000	16700	0,39	1,72	2,57	1,69	
	920	336		232/500BL1	232/500BL1K	1100	10500	17800	0,39	1,74	2,59	1,7	
	530	710	136		239/530	239/530K	400	2940	6450	0,17	3,95	5,88	3,86
710		136		239/530L1	239/530L1K	400	2940	6450	0,17	3,95	5,88	3,86	
780		185		230/530B	230/530BK	710	4850	9350	0,22	3,03	4,52	2,97	
780		185		230/530BL1	230/530BL1K	710	4850	9350	0,22	3,03	4,52	2,97	
780		250		240/530B	240/530BK30	700	6200	12700	0,3	2,24	3,33	2,19	
870		272		231/530B	231/530BK	920	7800	14200	0,3	2,22	3,3	2,17	
870		335		241/530B	241/530BK30	910	9 250	17 400	0,38	1,79	2,67	1,75	
980		355		232/530BL1	232/530BL1K	1210	11500	19800	0,39	1,74	2,59	1,7	
560		750	140		239/560	239/560K	525	3200	6900	0,16	4,1	6,1	4,01
	820	195		230/560B	230/560BK	800	5350	10500	0,22	3,03	4,51	2,96	
	820	195		230/560BL1	230/560BL1K	800	5350	10500	0,22	3,03	4,51	2,96	
	820	258		240/560B	240/560BK30	750	6750	14100	0,3	2,29	3,4	2,24	
	920	280		231/560B	231/560BK	1000	8550	15500	0,3	2,27	3,38	2,22	
	920	280		231/560BL1	231/560BL1K	1000	8550	15500	0,3	2,27	3,38	2,22	
	920	355		241/560B	241/560BK30	1030	11100	20800	0,39	1,75	2,61	1,71	
	1030	365		232/560B	232/560BK	1320	12300	21100	0,36	1,88	2,8	1,84	

Bearings available with cylindrical and tapered bores Bearings with tapered bores are generally fitted with adapter or withdrawal sleeves. All types of clearances are available from stock or on request. Special clearances and special precisions are available on request.
*NTN-SNR ULTAGE bearing

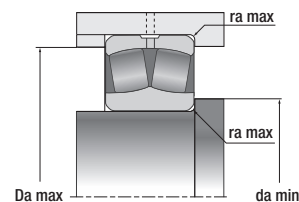
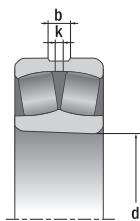
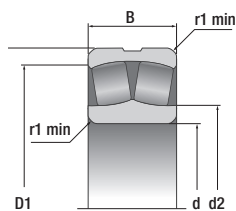

	Thermal reference speed	Limiting speed	Mass Cylindrical bore	Dimensions						Fitting dimensions				
				rpm	kg	Number of lubrication holes on the outer ring	b	k	r ₁ min	d ₂	D ₁	d _a min	D _a max	r _a max
							mm						mm	
			74,9	8	16	10	4	454	522	435	545	4		
			157	8	20	12	5	471	562	442	598	4		
			157	8	20	12	5	471	562	442	598	4		
			210	8	27	16	5	465	551	442	598	4		
			210	8	27	16	5	465	551	442	598	4		
			354	8	33	20	6	488	611	448	672	5		
			440	8	33	20	6	477	592	448	672	5		
			440	8	33	20	6	477	592	448	672	5		
			544	8	33	20	7,5	501	643	456	724	6		
			101	8	16	10	4	495	551	458	582	3		
			181	8	20	12	6	490	585	468	622	5		
			181	8	20	12	6	490	585	468	622	5		
			245	8	33	20	6	486	576	468	622	5		
			245	8	33	20	6	486	576	468	622	5		
			370	8	33	20	6	504	627	468	692	5		
			370	8	33	20	6	504	627	468	692	5		
			456	8	33	20	6	498	614	468	692	5		
			456	8	33	20	6	498	614	468	692	5		
			600	8	33	20	7,5	525	671	476	754	6		
			600	8	33	20	7,5	525	671	476	754	6		
			107	8	16	10	4	514	572	478	602	3		
			206	8	27	16	6	512	613	488	652	5		
			206	8	27	16	6	512	613	488	652	5		
			276	8	33	20	6	509	604	488	652	5		
			443	8	33	20	7,5	534	660	496	724	6		
			443	8	33	20	7,5	534	660	496	724	6		
			550	8	33	20	7,5	523	645	496	724	6		
			704	8	33	20	7,5	547	703	496	794	6		
			123	8	20	12	5	538	598	502	628	4		
			123	8	20	12	5	538	598	502	628	4		
			217	8	27	16	6	532	633	508	672	5		
			217	8	27	16	6	532	633	508	672	5		
			285	8	33	20	6	530	625	508	672	5		
			285	8	33	20	6	530	625	508	672	5		
			492	8	33	20	7,5	554	687	516	754	6		
			492	8	33	20	7,5	554	687	516	754	6		
			608	8	33	20	7,5	546	671	516	754	6		
			608	8	33	20	7,5	546	671	516	754	6		
			814	8	33	20	7,5	574	737	516	834	6		
			814	8	33	20	7,5	574	737	516	834	6		
			131	8	20	12	5	547	621	522	648	4		
			131	8	20	12	5	547	621	522	648	4		
			226	8	27	16	6	552	653	528	692	5		
			226	8	27	16	6	552	653	528	692	5		
			295	8	33	20	6	550	646	528	692	5		
			295	8	33	20	6	550	646	528	692	5		
			584	8	33	20	7,5	580	724	536	794	6		
			716	8	42	25	7,5	572	703	536	794	6		
			1000	8	42	25	7,5	600	773	536	884	6		
			157	8	20	12	5	579	654	552	688	4		
			157	8	20	12	5	579	654	552	688	4		
			306	8	27	16	6	594	704	558	752	5		
			306	8	27	16	6	594	704	558	752	5		
			413	8	33	20	6	586	688	558	752	5		
			653	8	33	20	7,5	617	757	566	834	6		
			800	8	42	25	7,5	605	737	566	834	6		
			1200	8	42	25	9,5	600	723	574	936	8		
			182	8	20	12	5	547	692	582	728	4		
			353	8	27	16	6	627	741	588	792	5		
			353	8	27	16	6	627	741	588	792	5		
			467	8	33	20	6	620	726	588	792	5		
			752	8	33	20	7,5	650	801	596	884	6		
			752	8	33	20	7,5	650	801	596	884	6		
			948	8	42	25	7,5	638	787	596	884	6		
			1360	12	42	25	9,5	677	867	604	986	8		

SPHERICAL ROLLER BEARING REFERENCES

Overall dimensions			ULTAGE	Designations		Fatigue load limit	Dynamic load		Calculation factors			
d	D	B		Cylindrical bore	Tapered bore	C ₀	Dynamic C	Static C ₀	e	Y ₁	Y ₂	Y ₀
mm						kN						
600	800	150		239/600L1	239/600L1K	490	3600	8000	0,18	3,85	5,73	3,76
	870	200		230/600B	230/600BK	835	5800	12000	0,21	3,17	4,72	3,1
	870	200		230/600BL1	230/600BL1K	835	5800	12000	0,21	3,17	4,72	3,1
	870	272		240/600BL1	240/600BL1K30	750	7150	15600	0,29	2,33	3,47	2,28
	980	300		231/600B	231/600BK	1160	10000	18400	0,3	2,22	3,3	2,17
	980	375		241/600BL1	241/600BL1K30	1130	11900	23200	0,37	1,81	2,7	1,77
	1090	388		232/600B	232/600BK	930	13600	23700	0,36	1,86	2,77	1,82
630	850	165		239/630	239/630K	545	4100	9250	0,18	3,66	5,46	3,58
	850	165		239/630L1	239/630L1K	545	4100	9250	0,18	3,66	5,46	3,58
	920	212		230/630B	230/630BK	950	6550	13000	0,22	3,14	4,67	3,07
	920	290		240/630B	240/630BK30	915	8400	17900	0,3	2,28	3,4	2,23
	1030	315		231/630B	231/630BK	1190	10700	19900	0,3	2,27	3,38	2,22
	1030	400		241/630B	241/630BK30	1200	12900	25000	0,38	1,78	2,66	1,74
	1150	412		232/630B	232/630BK	1540	15200	26800	0,36	1,87	2,78	1,83
670	900	170		239/670	239/670K	795	4550	10300	0,18	3,76	5,59	3,67
	980	230		230/670B	230/670BK	1000	7300	14600	0,22	3,07	4,57	3
	980	308		240/670B	240/670BK30	1040	9650	20600	0,29	2,29	3,41	2,24
	1090	336		231/670B	231/670BK	1400	12500	23600	0,3	2,22	3,3	2,17
	1090	412		241/670B	241/670BK30	1340	14100	28000	0,37	1,83	2,73	1,79
	1220	438		232/670B	232/670BK	1770	17900	32000	0,36	1,89	2,81	1,85
710	950	180		239/710	239/710K	665	4950	11500	0,18	3,85	5,73	3,76
	950	180		239/710L1	239/710L1K	665	4950	11500	0,18	3,85	5,73	3,76
	1030	236		230/710B	230/710BK	1140	8000	16200	0,22	3,02	4,5	2,96
	1030	236		230/710BL1	230/710BL1K	1140	8000	16200	0,22	3,02	4,5	2,96
	1030	315		240/710B	240/710BK30	1150	10300	22500	0,29	2,36	3,51	2,31
	1150	345		231/710B	231/710BK	1470	13000	24900	0,29	2,32	3,45	2,27
	1150	438		241/710B	241/710BK30	1190	16100	32000	0,37	1,83	2,72	1,79
	1280	450		232/710B	232/710BK	1200	18100	32500	0,35	1,91	2,84	1,87
750	1000	185		239/750	239/750K	990	5600	13000	0,17	3,9	5,81	3,81
	1090	250		230/750B	230/750BK	1290	9100	18300	0,21	3,2	4,76	3,13
	1090	335		240/750B	240/750BK30	1230	11300	24600	0,29	2,35	3,49	2,29
	1220	365		231/750B	231/750BK	1130	14300	27200	0,29	2,32	3,45	2,27
	1360	475		232/750B	232/750BK	1980	20300	36500	0,35	1,92	2,86	1,88
800	1060	195		239/800	239/800K	1040	6000	13700	0,17	4,05	6,04	3,96
	1150	258		230/800B	230/800BK	1340	9350	19500	0,21	3,15	4,69	3,08
	1150	345		240/800B	240/800BK30	1360	12400	27800	0,28	2,41	3,59	2,36
	1280	375		231/800B	231/800BK	1780	16000	31000	0,29	2,32	3,45	2,27
850	1120	200		239/850	239/850K	1080	6500	15100	0,16	4,25	6,32	4,15
	1220	272		230/850B	230/850BK	1510	10900	22700	0,2	3,32	4,95	3,25
	1220	365		240/850B	240/850BK30	1490	13900	31500	0,28	2,42	3,61	2,37
	1360	400		231/850B	231/850BK	1380	17300	34000	0,28	2,37	3,54	2,32
900	1180	206		239/900L1	239/900L1K	1230	7400	17300	0,16	4,32	6,44	4,23
	1280	280		230/900B	230/900BK	1580	11400	24700	0,2	3,32	4,95	3,25
	1280	375		240/900B	240/900BK30	1580	14700	33500	0,27	2,48	3,7	2,43
	1420	412		231/900B	231/900BK	2030	18700	38000	0,28	2,42	3,6	2,36
950	1250	224		239/950	239/950K	1390	8650	20500	0,16	4,2	6,26	4,11
	1360	300		230/950B	230/950BK	1750	12800	28400	0,21	3,26	4,85	3,18
	1360	412		240/950B	240/950BK30	1780	17200	40000	0,28	2,39	3,56	2,34
1000	1320	236		239/1000L1	239/1000L1K	1520	9550	22700	0,16	4,21	6,26	4,11
	1420	308		230/1000B	230/1000BK	1460	13800	30000	0,2	3,37	5,02	3,29
	1420	412		240/1000B	240/1000BK30	1890	17800	42000	0,27	2,51	3,73	2,45
1060	1400	250		239/1060	239/1060K	1670	10400	24700	0,16	4,2	6,26	4,11
	1500	325		230/1060B	230/1060BK	1610	15100	33500	0,2	3,36	5	3,28
	1500	438		240/1060B	240/1060BK30	2060	19800	47000	0,27	2,49	3,71	2,44
1120	1460	250		239/1120	239/1120K	1470	10900	26700	0,15	4,42	6,58	4,32
	1580	345		230/1120B	230/1120BK	2310	17400	39000	0,21	3,19	4,75	3,12
	1580	462		240/1120BL1	240/1120BL1K30	2230	21700	52500	0,27	2,5	3,72	2,44
1180	1540	272		239/1180	239/1180K	1650	12200	29800	0,15	4,4	6,56	4,31
1250	1630	280		239/1250	239/1250K	1810	13400	33500	0,15	4,42	6,58	4,32
1320	1720	300		239/1320	239/1320K	1930	15100	38000	0,16	4,34	6,46	4,24
1400	1820	315		239/1400	239/1400K	2570	16800	43000	0,15	4,39	6,54	4,29

Bearings available with cylindrical and tapered bores Bearings with tapered bores are generally fitted with adapter or withdrawal sleeves. All types of clearances are available from stock or on request. Special clearances and special precisions are available on request.
*NTN-SNR ULTAGE bearing

	Thermal reference speed	Limiting speed	Mass Cylindrical bore	Dimensions						Fitting dimensions		
	rpm		kg	Number of lubrication holes on the outer ring	b	k	r ₁ min	d ₂	D ₁	d _a min	D _a max	r _a max
					mm						mm	
			218	8	20	12	5	654	739	622	778	4
			400	8	27	16	6	672	785	628	842	5
			400	8	27	16	6	672	785	628	842	5
			544	8	33	20	6	667	770	628	842	5
			908	8	33	20	7,5	694	860	636	944	6
			1130	8	42	25	7,5	685	832	636	944	6
			1540	12	42	25	9,5	722	919	644	1046	8
			277	8	27	16	6	690	781	658	822	5
			277	8	27	16	6	690	781	658	822	5
			481	8	33	20	7,5	704	834	666	884	6
			657	8	33	20	7,5	697	815	666	884	6
			1050	12	33	20	7,5	731	899	666	994	6
			1330	12	42	25	7,5	718	872	666	994	6
			1900	12	42	25	12	760	969	684	1096	10
			317	8	27	16	6	733	830	698	872	5
			594	8	33	20	7,5	750	886	706	944	6
			794	8	33	20	7,5	741	870	706	944	6
			1250	12	42	25	7,5	773	956	706	1054	6
			1530	12	42	25	7,5	764	926	706	1054	6
			2270	12	42	25	12	807	1034	724	1166	10
			375	8	27	16	6	778	876	738	922	5
			375	8	27	16	6	778	876	738	922	5
			663	12	33	20	7,5	792	937	746	994	6
			663	12	33	20	7,5	792	937	746	994	6
			884	12	33	20	7,5	783	916	746	994	6
			1420	12	42	25	9,5	822	1005	754	1106	8
			1800	12	42	25	9,5	805	979	754	1106	8
			2540	12	42	25	12	851	1081	764	1226	10
			412	8	27	16	6	818	924	778	972	5
			790	12	33	20	7,5	834	991	786	1054	6
			1060	12	42	25	7,5	828	969	786	1054	6
			1700	12	42	25	9,5	868	1066	794	1176	8
			3050	12	42	25	15	903	1149	814	1296	12
			487	12	27	16	6	868	983	828	1032	5
			890	12	33	20	7,5	893	1 049	836	1 114	6
			1190	12	42	25	7,5	881	1026	836	1114	6
			1890	12	42	25	9,5	912	1122	844	1236	8
			550	12	27	16	6	924	1043	878	1092	5
			1050	12	33	20	7,5	945	1114	886	1184	6
			1410	12	42	25	7,5	936	1089	886	1184	6
			2270	12	42	25	12	979	1194	904	1306	10
			623	12	33	20	6	974	1101	928	1152	5
			1170	12	33	20	7,5	999	1167	936	1244	6
			1570	12	42	25	7,5	988	1147	936	1244	6
			2500	12	42	25	12	1031	1251	954	1366	10
			774	12	33	20	7,5	1029	1165	986	1214	6
			1430	12	33	20	7,5	1063	1239	986	1324	6
			1970	12	42	25	7,5	1044	1213	986	1324	6
			916	12	33	20	7,5	1084	1230	1036	1284	6
			1580	12	33	20	7,5	1107	1294	1036	1384	6
			2110	12	42	25	7,5	1097	1272	1036	1384	6
			1090	12	33	20	7,5	1153	1400	1096	1364	6
			1850	12	42	25	9,5	1172	1368	1104	1456	8
			2450	12	42	25	9,5	1160	1343	1104	1456	8
			1140	12	33	20	7,5	1208	1362	1156	1424	6
			2160	12	42	25	9,5	1 234	1442	1164	1536	8
			2890	12	42	25	9,5	1 227	1418	1164	1536	8
			1390	12	33	20	7,5	1271	1437	1216	1504	6
			1600	12	33	20	7,5	1352	1525	1286	1594	6
			1900	12	33	20	7,5	1423	1605	1356	1684	6
			2230	12	33	20	9,5	1513	1703	1444	1776	8

MOUNTING SLEEVES

Ø shaft	Ø Bearing	Nut	Brake washer	Sleeves for bearings									
				Sleeve 213XX	Bearing 213XX	Sleeve 222XX	Bearing 222XX	Sleeve 231XX	Bearing 231XX	Sleeve 223XX	Bearing 223XX	Bearing 232XX	
20	25	KM5	MB5	H305	05	H305	05			H2305			
25	30	KM6	MB6	H306	06	H306	06			H2306			
30	35	KM7	MB7	H307	07	H307	07			H2307			
35	40	KM8	MB8	H308	08	H308	08			H2308	08		
40	45	KM9	MB9	H309	09	H309	09			H2309	09		
45	50	KM10	MB10	H310	10	H310	10			H2310	10		
50	55	KM11	MB11	H311	11	H311	11			H2311	11		
55	60	KM12	MB12	H312	12	H312	12			H2312	12		
60	65	KM13	MB13	H313	13	H313	13			H2313	13		
60	70	KM14	MB14	H314	14	H314	14			H2314	14		
65	75	KM15	MB15	H315	15	H315	15			H2315	15		
70	80	KM16	MB16	H316	16	H316	16			H2316	16		
75	85	KM17	MB17	H317	17	H317	17			H2317	17		
80	90	KM18	MB18	H318	18	H318	18			H2318	18	18	
85	95	KM19	MB19	H319	19	H319	19			H2319	19		
90	100	KM20	MB20	H320	20	H320	20	H3120	20	H2320	20	20	
100	110	KM22	MB22	H322	22	H322	22	H3122	22	H2322	22	22	
110	120	KM24	MB24			H3124	24	H3124	24	H2324	24	24	
115	130	KM26	MB26			H3126	26	H3126	26	H2326	26	26	
125	140	KM28	MB28			H3128	28	H3128	28	H2328	28	28	
135	150	KM30	MB30			H3130	30	H3130	30	H2330	30	30	
140	160	KM32	MB32			H3132	32	H3132	32	H2332	32	32	
150	170	KM34	MB34			H3134	34	H3134	34	H2334	34	34	
160	180	KM36	MB36			H3136	36	H3136	36	H2336	36	36	
170	190	KM38	MB38			H3138	38	H3138	38	H2338	38	38	
180	200	KM40	MB40			H3140	40	H3140	40	H2340	40	40	
200	220	HM44T	MB44			H3144H	44	H3144H	44	H2344H	44	44	
220	240	HM48T	MB48			H3148H	48	H3148H	48	H2348H	48	48	
240	260	HM52T	MB52			H3152H	52	H3152H	52	H2352H	52	52	
260	280	HM56T	MB56			H3156H	56	H3156H	56	H2356H	56	56	
280	300	HM3160	MS3160			H3160H	60	H3160H	60	H3260H	60	60	
300	320	HM3164	MS3164			H3164H	64	H3164H	64	H3264H		64	
320	340	HM3168	MS3168					H3168H	68	H3268H		68	
340	360	HM3172	MS3172					H3172H	72	H3272H		72	
360	380	HM3176	MS3176					H3176H	76	H3276H		76	
380	400	HM3180	MS3180					H3180H	80	H3280H		80	
400	420	HM3184	MS3184					H3184H	84	H3284H		84	
410	440	HM3188	MS3188					H3188H	88	H3288H		88	
430	460	HM3192	MS3192					H3192H	92	H3292H		92	
450	480	HM3196	MS3196					H3196H	96	H3296H		96	
470	500	HM31/500	MS31/500					H31/500H	/500	H32/500H		/500	
500	530	HM31/530	MS31/530					H31/530H	/530	H32/530H		/530	
530	560	HM31/560	MS31/560					H31/560H	/560	H32/560H		/560	
560	600	HM31/600	MS31/600					H31/600H	/600	H32/600H		/600	
600	630	HM31/630	MS31/630					H31/630H	/630	H32/630H		/630	
630	670	HM31/670	MS31/670					H31/670H	/670	H32/670H		/670	
670	710	HM31/710	MS31/710					H31/710H	/710	H32/710H		/710	
710	750	HM31/750	MS31/750					H31/750H	/750	H32/750H		/750	
750	800	HM31/800	MS31/800										

	Ø shaft	Ø bearing	Nut	Brake washer	Sleeves for bearings			
					Sleeve 230XX	Bearing 230XX	Sleeve 239XX	Bearing 239XX
	20	25						
	25	30						
	30	35						
	35	40						
	40	45						
	45	50						
	50	55						
	55	60						
	60	65						
	60	70						
	65	75						
	70	80						
	75	85						
	80	90						
	85	95						
	90	100						
	100	110			H2322	22		
	110	120	KML24	MBL24	H3024	24		
	115	130	KML26	MBL26	H3026	26		
	125	140	KML28	MBL28	H3028	28		
	135	150	KML30	MBL30	H3030	30		
	140	160	KML32	MBL32	H3032	32		
	150	170	KML34	MBL34	H3034	34		
	160	180	KML36	MBL36	H3036	36	H3936	36
	170	190	KML38	MBL38	H3038	38	H3938	38
	180	200	KML40	MBL40	H3040	40	H3940	40
	200	220	HM3044	MS3044	H3044H	44	H3944H	44
	220	240	HM3048	MS3048	H3048H	48	H3948H	48
	240	260	HM3052	MS3052	H3052H	52	H3952H	52
	260	280	HM3056	MS3056	H3056H	56	H3956H	56
	280	300	HM3060	MS3060	H3060H	60	H3960H	60
	300	320	HM3064	MS3064	H3064H	64	H3964H	64
	320	340	HM3068	MS3068	H3068H	68	H3968H	68
	340	360	HM3072	MS3072	H3072H	72	H3972H	72
	360	380	HM3076	MS3076	H3076H	76	H3976H	76
	380	400	HM3080	MS3080	H3080H	80	H3980H	80
	400	420	HM3084	MS3084	H3084H	84	H3984H	84
	410	440	HM3088	MS3088	H3088H	88	H3988H	88
	430	460	HM3092	MS3092	H3092H	92	H3992H	92
	450	480	HM3096	MS3096	H3096H	96	H3996H	96
	470	500	HM30/500	MS30/500	H30/500H	/500	H39/500H	/500
	500	530	HM30/530	MS30/530	H30/530H	/530	H39/530H	/530
	530	560	HM30/560	MS30/560	H30/560H	/560	H39/560H	/560
	560	600	HM30/600	MS30/600	H30/600H	/600	H39/600H	/600
	600	630	HM30/630	MS30/630	H30/630H	/630	H39/630H	/630
	630	670	HM30/670	MS30/670	H30/670H	/670	H39/670H	/670
	670	710	HM30/710	MS30/710	H30/710H	/710	H39/710H	/710
	710	750	HM30/750	MS30/750	H30/750H	/750	H39/750H	/750
	750	800	HM30/800	MS30/800	H30/800H	/800	H39/800H	/800

WITHDRAWAL SLEEVES

Ø shaft	Ø Bearing	Nut for shaft	Brake washer	Nut	Sleeves for bearings									
					Sleeve 213XX / 222XX	Bearing 213XX	Bearing 222XX	Sleeve 223XX	Bearing 223XX	Sleeve 231XX	Bearing 231XX	Sleeve 232XX	Bearing 232XX	
20	25					05	05							
25	30					06	06							
30	35					07	07							
35	40	KM7	MB7	KM9	AH308	08	08	AH2308	08					
40	45	KM8	MB8	KM10	AH309	09	09	AH2309	09					
45	50	KM9	MB9	KM11	AHX310	10	10	AHX2310	10					
50	55	KM10	MB10	KM12	AHX311	11	11	AHX2311	11					
55	60	KM11	MB11	KM13	AHX312	12	12	AHX2312	12					
60	65	KM12	MB12	KM14	AH313G	13	13	AH2313G	13					
65	70	KM13	MB13	KM15	AH314G	14	14	AHX2314G	14					
70	75	KM14	MB14	KM16	AH315G	15	15	AHX2315G	15					
75	80	KM15	MB15	KM18	AH316	16	16	AHX2316	16					
80	85	KM16	MB16	KM19	AHX317	17	17	AHX2317	17					
85	90	KM17	MB17	KM20	AHX318	18	18	AHX2318	18			AHX3218	18	
90	95	KM18	MB18	KM21	AHX319	19	19	AHX2319	19					
95	100	KM19	MB19	KM22	AHX320	20	20	AHX2320	20	AHX3120	20	AHX3220	20	
105	110	KM21	MB21	KM24	AHX322/ AHX3122	22	22			AHX3122	22	AHX3222G	22	
115	120	KM22	MB22	KM26	AHX3124		24	AHX2324G	24	AHX3124	24	AHX3224G	24	
125	130	KM24	MB24	KM28	AHX3126		26	AHX2326G	26	AHX3126	26	AHX3226G	26	
135	140	KM26	MB26	KM30	AHX3128		28	AHX2328G	28	AHX3128	28	AHX3228G	28	
145	150	KM28	MB28	KM32	AHX3130G		30	AHX2330G	30	AHX3130G	30	AHX3230G	30	
150	160	KM30	MB30	KM34	AH3132G		32	AH2332G	32	AH3132G	32	AH3232G	32	
160	170	KM32	MB32	KM36	AH3134G		34	AH2334G	34	AH3134G	34	AH3234G	34	
170	180	KM34	MB34	KM38	AH2236G		36	AH2336G	36	AH3136G	36	AH3236G	36	
180	190	KM36	MB36	KM40	AH2238G		38	AH2338G	38	AH3138G	38	AH3238G	38	
190	200	KM38	MB38	HM44T	AH2240		40	AH2340	40	AH3140	40	AH3240	40	
200	220	KM40	MB40	HM48T	AOH2244		44	AOH2344	44	AOH3144	44			
220	240	HM44T	MB44	HM52T	AOH2248		48	AOH2348	48	AOH3148	48			
240	260	HM48T	MB48	HM56T	AOH2252G		52	AOH2352G	52	AOH3152G	52			
260	280	HM52T	MB52	HM3160	AOH2256G		56	AOH2356G	56	AOH3156G	56			
280	300	HM56T	MB56	HM3164	AOH2260G		60			AOH3160G	60	AOH3260G	60	
300	320	HM3060	MS3060	HM3168	AOH2264G		64			AOH3164G	64	AOH3264G	64	
320	340	HM3064	MS3064	HM3172						AOH3168G	68	AOH3268G	68	
340	360	HM3068	MS3068	HM3176						AOH3172G	72	AOH3272G	72	
360	380	HM3072	MS3072	HM3180						AOH3176G	76	AOH3276G	76	
380	400	HM3076	MS3076	HM3184						AOH3180G	80	AOH3280G	80	
400	420	HM3080	MS3080	HM3188						AOH3184G	84	AOH3284G	84	
420	440	HM3084	MS3084	HM3192						AOHX3188G	88	AOHX3288G	88	
440	460	HM3088	MS3088	HM3196						AOHX3192G	92	AOHX3292G	92	
460	480	HM3092	MS3092	HM31/500						AOHX3196G	96	AOHX3296G	96	
480	500	HM3096	MS3096	HM31/530						AOHX31/500G	/500	AOHX32/500G	/500	
500	530	HM30/500	MS30/500	HM31/560						AOH31/530	/530	AOH32/530G	/530	
530	560	HM30/530	MS30/530	HM31/600						AOH31/560	/560	AOHX32/560	/560	
570	600	HM30/560	MS30/560	HM31/630						AOHX31/600	/600	AOHX32/600G	/600	
600	630	HM30/600	MS30/600	HM31/670						AOH31/630	/630	AOH32/630G	/630	
630	670	HM30/630	MS30/630	HM31/710						AOHX31/670	/670	AOH32/670G	/670	
670	710	HM30/670	MS30/670	HM31/750						AOHX31/710	/710	AOH32/710G	/710	
710	750	HM30/710	MS30/710	HM31/800						AOH31/750	/750	AOH32/750	/750	
750	800	HM30/750	MS30/750	HM31/850						AOH31/800	/800			
800	850	HM30/800	MS30/800	HM31/900						AOH31/850	/850	AOH32/850	/850	
850	900	HM30/850	MS30/850	HM31/950						AOH31/900	/900			
900	950													

	Ø shaft	Ø Bearing	Shaft nut	Brake washer	Sleeves for bearings								
					Nut	Sleeve 230XX	Bearing 230XX	Nut	Sleeve 240XX	Bearing 240XX	Nut	Sleeve 241XX	Bearing 241XX
	20	25											
	25	30											
	30	35											
	35	40	KM7	MB7									
	40	45	KM8	MB8									
	45	50	KM9	MB9									
	50	55	KM10	MB10									
	55	60	KM11	MB11									
	60	65	KM12	MB12									
	65	70	KM13	MB13									
	70	75	KM14	MB14									
	75	80	KM15	MB15									
	80	85	KM16	MB16									
	85	90	KM17	MB17									
	90	95	KM18	MB18									
	95	100	KM19	MB19									
	105	110	KM21	MB21							KM23	AH24122	22
	115	120	KM22	MB22	KM26	AHX3024	24	KM25	AH24024	24	KM26	AH24124	24
	125	130	KM24	MB24	KM28	AHX3026	26	KM27	AH24026	26	KM28	AH24126	26
	135	140	KM26	MB26	KM30	AHX3028	28	KM29	AH24028	28	KM30	AH24128	28
	145	150	KM28	MB28	KM32	AHX3030	30	KM31	AH24030	30	KM32	AH24130	30
	150	160	KM30	MB30	KM34	AH3032	32	KM34	AH24032	32	KM34	AH24132	32
	160	170	KM32	MB32	KM36	AH3034	34	KM36	AH24034	34	KM36	AH24134	34
	170	180	KM34	MB34	KM38	AH3036	36	KM38	AH24036	36	KM38	AH24136	36
	180	190	KM36	MB36	KM40	AH3038G	38	KM40	AH24038	38	KM40	AH24138	38
	190	200	KM38	MB38	HM44T	AH3040G	40	HM42T	AH24040	40	HM42T	AH24140	40
	200	220	KM40	MB40	HM48T	AOH3044G	44	HM46T	AOH24044	44	HM46T	AOH24144	44
	220	240	HM44T	MB44	HM52T	AOH3048	48	HM50T	AOH24048	48	HM52T	AOH24148	48
	240	260	HM48T	MB48	HM56T	AOH3052	52	HM56T	AOH24052G	52	HM56T	AOH24152	52
	260	280	HM52T	MB52	HM3060	AOH3056	56	HM3160	AOH24056G	56	HM3160	AOH24156	56
	280	300	HM56T	MB56	HM3064	AOH3060	60	HM3164	AOH24060G	60	HM3164	AOH24160	60
	300	320	HM3060	MS3060	HM3068	AOH3064G	64	HM3168	AOH24064G	64	HM3168	AOH24164	64
	320	340	HM3064	MS3064	HM3072	AOH3068G	68	HM3072	AOH24068	68	HM3172	AOH24168	68
	340	360	HM3068	MS3068	HM3076	AOH3072G	72	HM3076	AOH24072	72	HM3176	AOH24172	72
	360	380	HM3072	MS3072	HM3080	AOH3076G	76	HM3080	AOH24076	76	HM3180	AOH24176	76
	380	400	HM3076	MS3076	HM3084	AOH3080G	80	HM3084	AOH24080	80	HM3184	AOH24180	80
	400	420	HM3080	MS3080	HM3088	AOH3084G	84	HM3088	AOH24084	84	HM3188	AOH24184	84
	420	440	HM3084	MS3084	HM3092	AOHX3088G	88	HMLL92T	AOH24088	88	HM3192	AOH24188	88
	440	460	HM3088	MS3088	HM3096	AOHX3092G	92	HMLL96T	AOH24092	92	HM3196	AOH24192	92
	460	480	HM3092	MS3092	HM30/500	AOHX3096G	96	HMLL100T	AOH24096	96	HM31/500	AOH24196	96
	480	500	HM3096	MS3096	HM30/530	AOHX30/500G	/500	HM106T	AOH240/500	/500	HM31/530	AOH241/500	/500
	500	530	HM30/500	MS30/500	HM30/560	AOH30/530	/530	HM31/560	AOH240/530G	/530	HM31/560	AOH241/530G	/530
	530	560	HM30/530	MS30/530	HM30/600	AOHX30/560	/560	HM31/600	AOH240/560G	/560	HM31/600	AOH241/560G	/560
	570	600	HM30/560	MS30/560	HM30/630	AOHX30/600	/600	HMLL125T	AOHX240/600	/600	HM31/630	AOHX241/600	/600
	600	630	HM30/600	MS30/600	HM30/670	AOH30/630	/630	HM31/670	AOH240/630G	/630	HM31/670	AOH241/630G	/630
	630	670	HM30/630	MS30/630	HM30/710	AOH30/670	/670	HM31/710	AOH240/670G	/670	HM142T	AOH241/670	/670
	670	710	HM30/670	MS30/670	HM30/750	AOHX30/710	/710	HM31/750	AOH240/710G	/710	HM150T	AOH241/710	/710
	710	750	HM30/710	MS30/710	HM30/800	AOH30/750	/750	HM31/800	AOH240/750G	/750			
	750	800	HM30/750	MS30/750	HM30/850	AOH30/800	/800	HM31/850	AOH240/800G	/800			
	800	850	HM30/800	MS30/800	HM30/900	AOH30/850	/850	HM31/900	AOH240/850G	/850			
	850	900	HM30/850	MS30/850	HM30/950	AOH30/900	/900	HM31/950	AOH240/900	/900			
	900	950	HM30/950	MS30/950	HM30/1000	AOH30/950	/950	HM31/1000	AOH240/950	/950			

ASSOCIATED PLUMMER BLOCKS

SNCD OVERSIZE SPLIT PLUMMER BLOCK

In accordance with ISO 113:2010 for mounting spherical roller bearings with a cylindrical and tapered bore.



- Plummer block material: spheroidal graphite iron
- Compatible with temperatures down to -40°C
- Excellent heat dissipation with its extra-wide contact support surface
- Increased dimensional stability with a reinforced X-shaped sub-structure and wide circular rib around the bearing
- Less maintenance required and longer bearing service life
- For mounting spherical roller bearings in the 222XX, 223XX, 230XX and 231XX series
- Sealing systems: labyrinth and taconite seals for extreme conditions
- Different connection options available for lubrication or control systems
- For shaft diameters from 115 mm to 500 mm

SNC500 / SNCD500 SPLIT PLUMMER BLOCK

In accordance with ISO 113:2010 for mounting spherical roller bearings with a cylindrical and tapered bore.



- Plummer block material: lamellar graphite cast iron and/or spheroidal graphite iron (SNCD)
- Increased stability and dimensional rigidity with all types of load
- Excellent heat dissipation
- Fewer constraints in the bearing
- Less maintenance required and longer bearing service life
- Sealing systems: five types of seals available for all types of application
- Fast implementation and easy maintenance thanks to the enhanced design
- For shaft diameters from 20 mm to 140 mm

SPW/SFCW – ONE-PIECE PLUMMER BLOCK FOR HEAVY LOADS

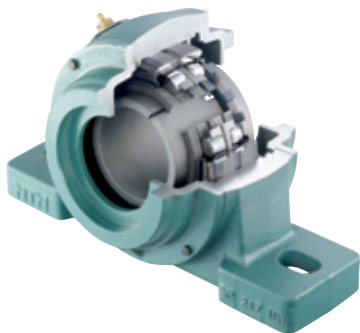

- Suited to highly demanding, heavy industrial environments
- Components treated for corrosion protection
- Enables rapid replacement of patented inserts
- Equipped with sealed spherical roller bearings
- Reduced maintenance time and increased productivity
- SPW range interchangeable with SN bearing housing units
- Shaft diameter: 50 mm – 140 mm



FLANGED ONE-PIECE PLUMMER BLOCK 722500 WITH GREASE LUBRICATION

Flanged one-piece plummer block for positioning a cylindrical or tapered spherical roller bearing mounted on an adapter sleeve

- Compact and robust bearing unit design
- Housing material: lamellar graphite cast iron
- Suitable for bearings in the following series: 12..K, 22..K, 222..K
- Version available with a plug (type A) or through-shaft (type B)
- Flange design with 3 or 4 mounting holes
- Integrity using a felt strip seal
- For shaft diameters from 20 mm to 100 mm
- Relubrication possible



SNOE OIL-LUBRICATED SPLIT PLUMMER BLOCK-UNIT

- Suited to spherical roller bearings
- Perfectly suited to operating conditions with heavy loads and high rotation speeds
- Material: EN-GJS-600-3 for high rigidity
- Internal distribution of oil via a lubrication ring
- Seal by means of a labyrinth seal system
- Fitted with an oil level indicator
- Possible integration in an oil circulation system (with or without heating)
- Excellent heat dissipation
- Standard applications: industrial fans, hammer crushers, extraction, steelworks, chemical and petrochemical industries, power plants, ventilation mechanisms, drying systems, incinerators and air-conditioning systems
- Maximum shaft dimensions: 260 mm (the largest oil-lubricated plummer blocks available as standard on the market)



SNOL OIL-LUBRICATED SPLIT PLUMMER BLOCK-UNIT (COMPACT VERSION)

- Suited to spherical roller bearings
- Seal by means of a labyrinth seal system
- Can replace a grease-lubricated split plummer block-unit when the rotation speeds are too high or when the operating temperatures risk damaging the bearing
- Interchangeable with the same-size SN bearing housings
- Fitted with an oil level indicator
- Shaft diameter: 60 mm – 140 mm

LUBRICATION PRODUCTS

We can provide support for lubrication projects from design to installation, offering lubricants specially selected for specific applications, together with single-point or multi-point lubrication systems according to each process size and requirements.

TYPES OF GREASE AND OIL

Designed for the demands of each application to ensure that bearings operate at their best.



Universal



Heavy Duty



Vib



High Temp MP



Ultra High Temp



Food AL



High Speed+



Food Chain Oil



Chain Oil



AUTOMATIC SINGLE-POINT LUBRICATION SYSTEMS

Automatic single-point lubrication systems ensure constant and regular lubrication of the bearings.

They can easily be incorporated into different types of application (mechanical and motor industries, steelworks, paper mills, etc.) and they provide improved lubrication systems without involving any changes in installations.



MULTI-POINT LUBRICATION: POLIPUMP

A POLIPUMP is the lubrication system that is best suited to lubricate several points. Available in versions with 12, 24 or 35 outlets, providing independent output rates of between 0.01 cc and 0.13 cc per cycle for each point, at a maximum pressure level of 80 bar, and featuring a large grease tank, a POLIPUMP constitutes a very widespread lubrication system that is very easy to use.

"Our lubrication recommendations: it is vital that satisfactory lubrication is obtained as soon as the bearings start to rotate. In the case of lubrication using grease, the grease needs to occupy the entire available volume and, in particular, the space between the cage and the inner ring."

ALL INCLUSIVE - PERFORMANCE - INNOVATION

SNCD



LARGE PLUMMER BLOCK HOUSINGS SNCD

All inclusive as standard

NTN 

www.ntn-snr.com



With You

A close-up photograph of a silver metal rim, likely from a bicycle or a similar vehicle. The rim is curved and features a row of cylindrical rollers or bearings along its inner edge. The word "ULTAGE" is engraved in a serif font on the lower part of the rim. The background is a plain, light-colored surface.

ULTAGE®





SPHERICAL ROLLER BEARINGS

This document is the exclusive property of NTN-SNR ROULEMENTS. Any total or partial reproduction hereof without the prior consent of NTN-SNR ROULEMENTS is strictly prohibited. Legal action may be brought against anyone breaching the terms of this paragraph.

NTN-SNR ROULEMENTS shall not be held liable for any errors or omissions that may have crept into this document despite the care taken in drafting it. Due to our policy of continuous research and development, we reserve the right to make changes without notice to all or part of the products and specifications mentioned in this document.

© NTN-SNR ROULEMENTS, international copyright 2020.

