

MULTI’PULSE AC **Lubrication pump for fixed** **Industrial applications**

User operation and Maintenance **manual** **Warranty**

Manual drawn up in accordance with EC Directive 2006/42



***Pour obtenir ce manuel d'utilisation en français, veuillez consulter notre site Internet :
www.ntn-snr.com***

***Um unsere deutsche Gebrauchsanweisung zu erhalten, besuchen Sie uns auf unserer
Homepage: www.ntn-snr.com***

***Para conseguir este libro de instrucciones en español, consultar nuestro sitio Internet :
www.ntn-snr.com***

***Per ricevere questa guida utente in italiano, si prega di visitare il nostro sito Web:
www.ntn-snr.com***

1. TABLE OF CONTENTS

1. Table of contents	p.2	10. Maintenance procedure	p.16
2. Introduction	p.2	11. Disposal	p.17
3. General description	p.2	12. Spare Parts	p.17
4. Product identification	p.3	13. Dimensions	p.17
5. Technical characteristics	p.4	13. Handling and transportation	p.18
6. Pump components	p.5	14. Operating hazards	p.18
7. Unpacking and installing	p.6	15. Precautions	p.19
8. Operating instructions	p.9	16. Warranty	p.19
9. Troubleshooting	p.15	17. Declaration of conformity	p.20

2. INTRODUCTION

This user and maintenance manual refers to the MULTI'PULSE AC lubrication system.

This manual should be conserved in such a way that it remains undamaged over time and is readily available to personnel needing to consult it.

The manufacturer reserves the right to update the product and/or the user and maintenance manual without the obligation to revise previous versions. Further copies of this manual, updates or clarifications can be obtained by directly contacting Experts & Tools at NTN-SNR Roulements, or to consult our web site at www.ntn-snr.com.

The use of the equipment referred to in this manual must be entrusted to qualified personnel with a basic knowledge of mechanics, hydraulics and electrical systems.

It is the responsibility of the installer to use tubing suitable for the system; the use of inadequate tubing can cause problems with the pump, injury to persons and create pollution.

Loosening of connections can cause serious safety problems; carry out a check before and after installation and, if necessary retighten them.

Never exceed the maximum working pressure values permitted for the panel and the components connected to it.

Before any maintenance or cleaning operation disconnect the power supply, close off the air supply and discharge the pressure from inside the equipment and the tubing connected to it.

Do not subject the panel, the connections, the tubing or parts under pressure to violent impacts; damaged tubing or connections are dangerous and should be immediately replaced.

After long periods of inactivity check air tightness of all parts subjected to pressure.

Personnel must use personal protection equipment, clothing and tools adequate for the location and the use of the panel both during its operation and during maintenance operations.

The panel, and any accessories mounted on it, should be carefully checked immediately on receipt and in the event of any discrepancy or complaint the NTN-SNR Roulements Sales department should be contacted without delay.

NTN-SNR Roulements declines to accept any responsibility for injuries to persons or damage to property in the event of the non-observance of the information presented in this manual.

Any modification to component parts of the system or the different destination of use of this system or its parts without prior written authorization from NTN-SNR Roulements will absolve the latter from any responsibility for injury to persons and/or damage to property and will release them from all obligations arising from the guarantee.

3. GENERAL DESCRIPTION

3.1 CENTRALIZED LUBRICATION – GENERAL OPERATING INFORMATION

Centralized lubrication systems are designed to provide oil or grease to lubricating points on industrial or mobile machinery. Such systems considerably reduce the cost of maintaining machinery on which they are installed, eliminating machinery downtime caused by poor lubrication as well as prolonging the life of the machinery in general.

Additionally, a centralized lubrication system allows difficult to reach lubrication points to be lubricated at frequent intervals that would otherwise be hard to access under normal conditions.

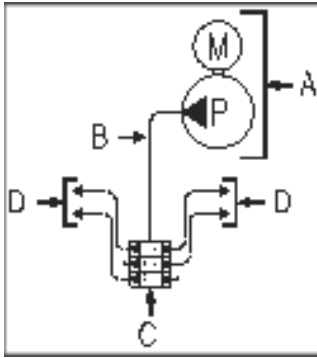

The diagram on the left shows a typical schematic of a simple centralized lubrication system.

The main components are:

A – Electric Pump with Reservoir (eg. MULTI’PULSE AC Pump).

B – Primary lubrication line for distributing grease.

C – Distributor elements that meters grease into a number of points.

D – Secondary tubing that delivers grease to the lube point.

The pump feeds a distributor element that shares and doses the ratio of grease or oil between the several points. The MULTI’PULSE AC Pumps have been designed to provide the pumping solution for such systems used in industrial or mobile applications for greases up to NLGI 2 consistency and oils with minimum viscosity of 46 cSt.

3.2 MULTI’PULSE AC ELECTRIC GREASE PUMP FOR FIXED APPLICATIONS

MULTI’PULSE AC is an electric piston pump with the pumping element operated from a camshaft connected to a reducing gearbox. It can be fitted with up to 3 pumping elements (1 as standard) which are available with or without an integrated pre-set bypass (pressure safety valve). The MULTI’PULSE AC also has a modular build reservoir supplied in 5 liter capacity. Additionally a minimum level sensing device is fitted as standard at the base of the unit.

MULTI’PULSE AC is available as both with an integrated automatic control board that controls and monitors the pump and lubrication cycle or a manual version where the pump motor is controlled externally by applying and removing power. The main body of the pump is made from high performance robust plastic and is compact in size designed to withstand tough environments.

The grease version of the MULTI’PULSE AC includes a stirrer device with a reservoir wiper that help to eliminate air present in the grease and facilitate pumping even at lower temperatures.

4. PRODUCT IDENTIFICATION

On the side of the pump there is a label that indicates part number of the product, operating voltage and basic characteristics.

Accessories	
LUBSO PUMPING ELEMENT AC	Pumpinp element Ø6mm with PSV integrated
LUBSO MULTIPULSE AC FIXING KIT	Kit to assemble the distributor onto the MULTI’PULSE AC 110/230V pump

5. TECHNICAL CHARACTERISTICS

General technical characteristics				
Operating voltage	AC - 50Hz		AC - 60Hz	
	110 V	230 V	110 V	230 V
Current (nominal)	0,2 A	0,1 A	0,2 A	0,1 A
Current (peak)	0,3 A	0,2 A	0,3 A	0,2 A
Net weight with 5 Liter reservoir	7 kg (15.43 lb)			
Number of outlets / pumping elements	1 as standard (3 max.)			
Outlet thread	1/4" BSP			
Nominal output per pumping element	2,8 cm ³ /min (0.17 in ³ /min) @ 20 RPM			
Working pressure	280 bar (4061 psi)			
Integrated By-pass pressure (for pumping elements with integrated PSV)	320 bar ± 30 bar (4641 psi ± 435 psi)			
Reservoir capacity	5 liters (1.32 gallons)			
Max grease consistency	NLGI 2			
Operating temperature	-25°C to +80°C			
Storage temperature	-30°C to +90°C			
Humidity	90 %			
IP Protection level	IP 65			
Noise level	< 70 dB (A)			
Control panel characteristics				
Operating Voltage	110VAC	Includes internal transformer		
	230VAC			
Maximum Output load capability	5A			
Short circuit & Overload protection	7.5A typical		10A max.	
Operating temperature	-20°C to +80°C			
Storage temperature	-30°C to +90°C			
Hardware protection	<ul style="list-style-type: none"> • Overload protection on motor and lamp • Integrated Motor protection • Spike voltage protection • Inverted Polarity protection 			
Memory for parameter storage	EEPROM			
Memory Life	Unlimited (no battery requirement)			
Minimum Level				
Max load	AUTOMATIC version		0,3A	@ 230V
	MANUAL version		0,25A	@ 120V

NOTE: Pump output has been determined at the following conditions: NLGI 2 Grease Standard environmental conditions (Temperature 20°C / 68°F, Pressure 1 ATM), Back pressure 50 bar (735 psi).

WARNING: Do not operate the unit outside the specified voltage ranges.

6. PUMP COMPONENTS

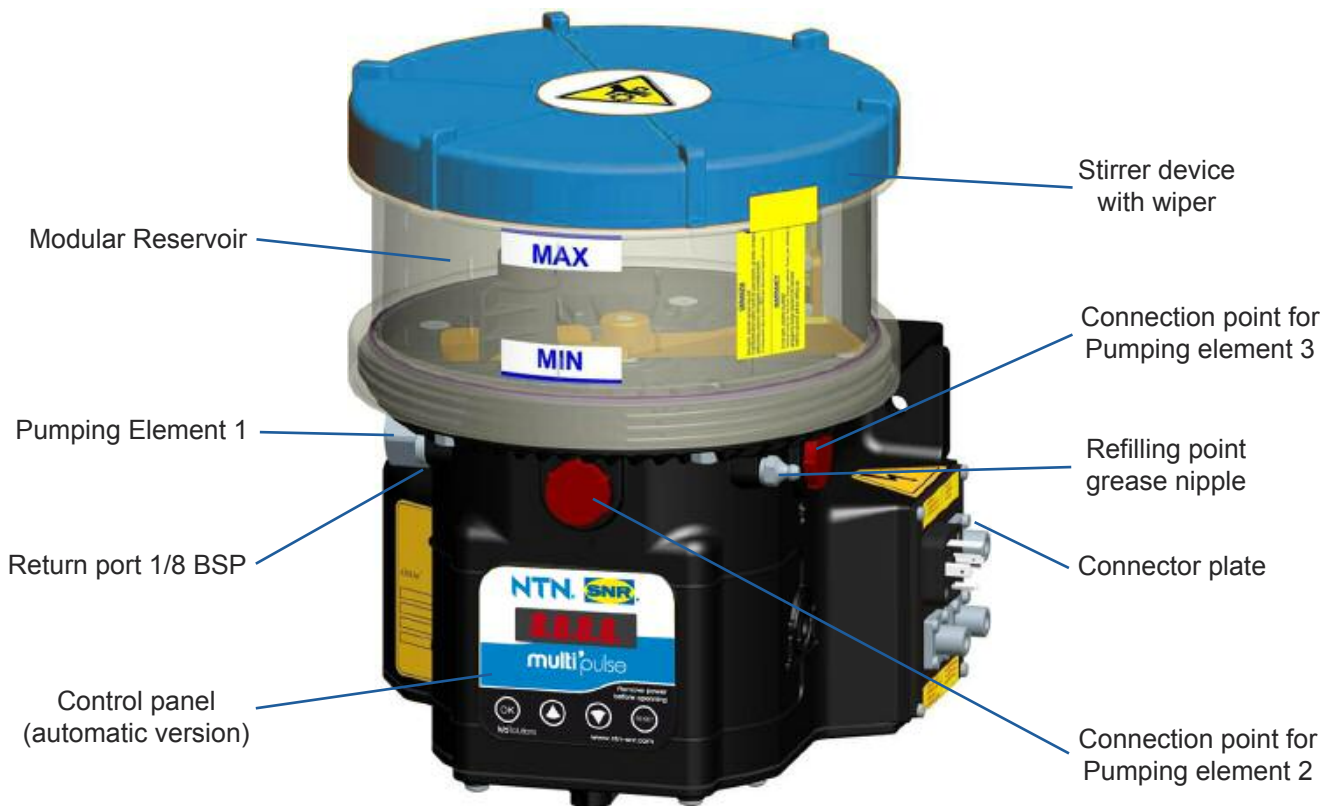

6.1 ELECTRONIC CONTROL BOARD

In the automatic version, pump and cycle control is managed by the onboard controller. Three operating modes are possible:

1. **CYCLE:** Lube and pause cycles are set using the built in timer or counting external inputs; the two condition work with every combinations.
2. **PULSE** Lube Cycle and Pause cycle are determined by external inputs. During of Lube Cycle, the cycle sensor can be monitored to ensure a correct system working. Pump can suspend the lube cycle if external pulses are not found.
3. **OFF:** Pump works as slave regarding the control of the machine.

The MULTI'PULSE AC pump has been designed in order to integrate quickly Lubso distributors elements. Programming instructions can be found in chapter 8 of this manual.

6.2 MINIMUM LEVEL

In manual version (no control board) the minimum level switch (Normally closed) opens when the minimum level is reached. With the automatic (controlled) version, a voltage free changeover contact NC/NA can be obtained to give a remote signal of minimum level.

6.3 CONNECTIONS & WIRING

A connector plate and wiring is available as standard. It is also possible to select another connector plate (consult NTN-SNR Roulements).

7. UNPACKING AND INSTALLING

7.1 UNPACKING

Once a suitable installation position has been identified, unpack the pump and prepare for installation. It is important to inspect the pump to ensure that there has been no damage during transportation. The packaging material used does not require any special disposal procedures. You should refer to your regional requirements.

7.2 INSTALLING THE CONNECTOR BASEPLATE

A base plate is delivered with the pump. See drawing chapter 7.7.1



Fig. 1

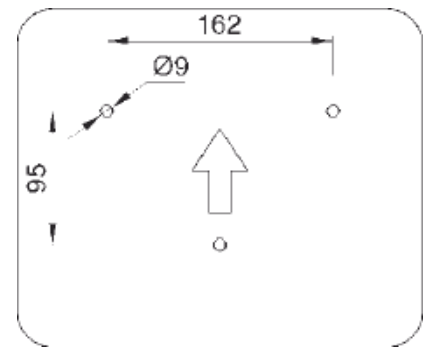

Fig. 2



7.3 INSTALLING THE PUMP

- In the box there is a mounting hole template as shown in the diagram here above. This can be used to drill the fixing holes. The fixing holes should be $\varnothing 9\text{mm}$ ($\varnothing 0.35$ inch). Use 3 screws to fix the pump into place.
- Locate the pump so that the filling point and the control panel are accessible by the user.
- Allow 100mm (4 inches) perimeter distance around the pump for easy access.
- Ideally, install the pump at a height that is easily and comfortably accessible by the user to facilitate maintenance and refilling.
- Do not install the pump where it may be submerged by liquids or in an excessively aggressive environment.
- Do not install the pump in hazardous areas where there may be flammable or explosive materials.
- Do not install near strong heat sources or electrical areas that may cause electrical interference with the control system.
- Ensure that tubing and wiring is appropriately secured and protected.



7.4 INSTALLING PUMPING ELEMENTS

The MULTI'PULSE AC pump is supplied with a single pumping element installed in Port 1.

Additional pumping elements can be installed on any of the additional pump port (2 or 3). It is also possible to move the pumping element 1 to another port if necessary, to simplify piping arrangements on the lubrication system. To install a new pumping element:

- Unscrew and remove the plastic plug with the O Ring that is installed on the standard product.
- Insert and screw the pumping element until it is fixed in position.
- Use 20Nm torque to secure the element.

WARNING: Based on the position of the internal cam drive it may be difficult to screw in the pumping element as it compresses the return spring. In this case, use another outlet or pay particular attention when inserting the pump element and ensure that it does not cross-thread.

7.5 HYDRAULIC CONNECTIONS

The hydraulic connection to the pump is via the pump outlets using adequate 1/4BSP fitting and tubing. Additionally there is a 1/8" BSP port that can be used as a return line or a remote refilling line. Ensure that any refilling system provides clean grease to the pump.

7.6 INSTALLING THE LUBSO DISTRIBUTOR DIVIDER VALVE

Under the base of the pump it is possible to install a LUBSO DISTRIBUTOR. Use our kit for this purpose which contains 2 screws and a bent rigid tube. Refer to the diagram below:



7.7 ELECTRICAL CONNECTIONS & WIRING

CAUTION: Before carrying out any electrical wiring you should check the label on the pump to ensure that the correct operating voltage is being used and ensure that all power is removed.

The electrical connection should be carried out by an electrician who has understood and identified the various connectors and wiring that has been selected for the system (operating voltage, connector types, remote control, cycle sensors).

Connect the pump to the power supply using the appropriate power connector (refer to 7.7.1 Connector types) again ensuring they are suitable for the selected voltage and frequency. The power cable should be adequately chosen to ensure it can handle the current at the specified voltage.

On 110V/230VAC versions it is strongly recommended that a 1A fuse T and a differential trip is installed with an activation level of 30 mA at 1 millisecond max. Isolation capability should be = 10kV minimum and nominal current ≥ 4Amps.

7.7.1 CONNECTOR TYPES

110V/230 V -50Hz / 60Hz VERSIONS :

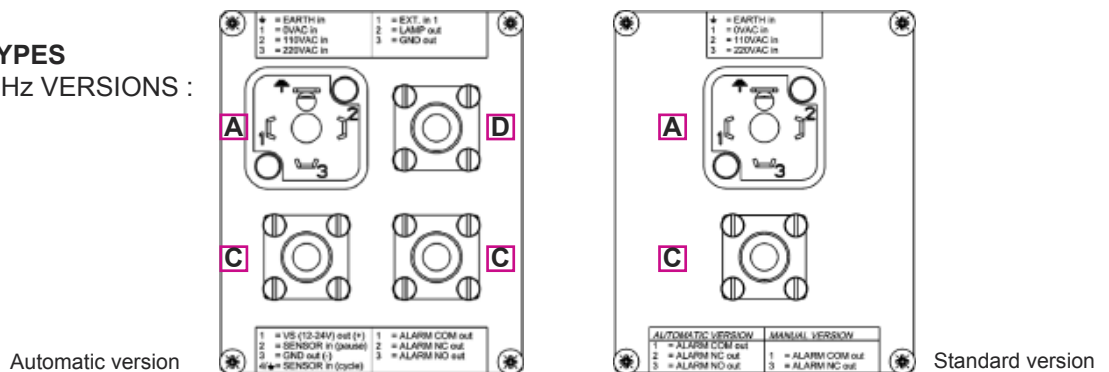

Wiring **A** POWER SUPPLY

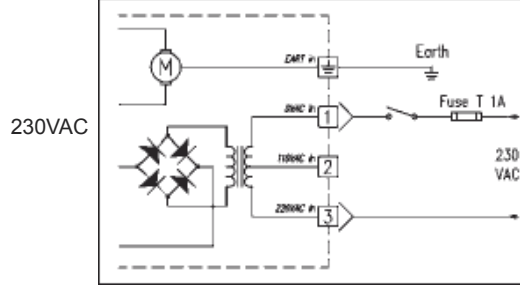
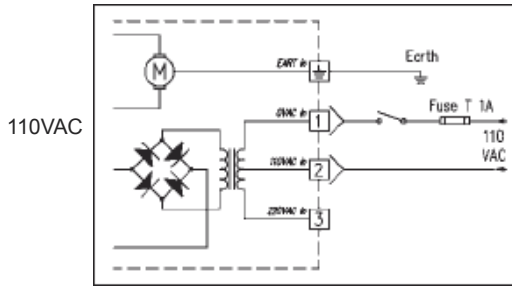

Wiring **C** MINIMUM LEVEL

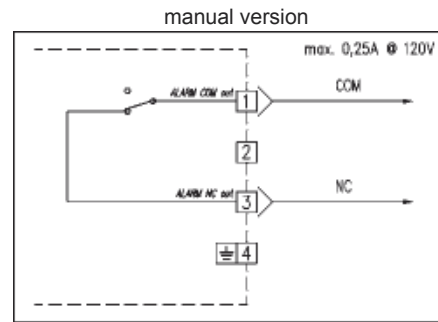
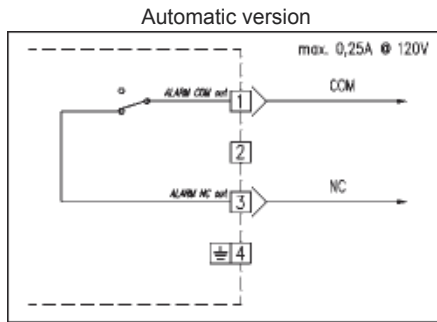

Wiring **D** REMOTE CONTROL

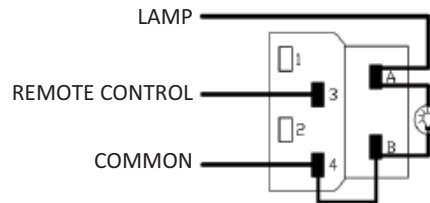
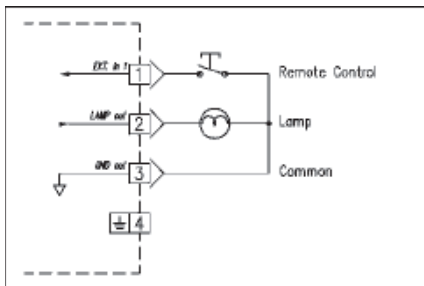

POWER	LAMP	OPTIONAL
230 Vac	12Vdc (3A max)	0039433
110 Vac	12Vdc (3A max)	0039433

Electric connection					
Connector	Nominal voltage	Poles	Cross section cable	IP	Max. A
A	250 V - 300 V	3 + \perp	1 mm ²	65	10 A
C	150 V	4	0,5 mm ²	68	4 A
D	230 V	4	0,5 mm ²	68	4 A

8. OPERATING INSTRUCTIONS

8.1 BEFORE PUTTING INTO OPERATION

Note that the unit should not be dismantled by the user if a fault is found.

- Use gloves when handling lubricants and ensure you have checked the lubricant safety data sheet.
- Do not use lubricants that are incompatible with NBR (Buna) seals.
- Ensure that you have complied with all health and safety requirements before putting the pump into service.
- Maintain proper hygiene standards. Never ignore any potential danger to health.
- Ensure all tubing and fittings are designed to handle the maximum system pressure.
- Check integrity in the pump. Ensure no damage;
- Check and fill the reservoir. If the reservoir is below the MIN level, follow procedure 8.3 to refill;
- Verify the pump is at the correct operating temperature and tubing is free of air bubbles;
- Check the unit is properly wired.

8.2 OPERATION

- Check and set the operating mode and parameter if using the automatic versions.
- Press the remote start button on your machine if using a manual version.
- Check that the pump is running.
- Check lubricant is being delivered to the greasing points as necessary.

8.3 REFILLING THE RESERVOIR

The refilling of the tank is carried out through the dedicated filling ports with adequate filtration to ensure clean lubricant. Continue to fill unit until the max level is reached/ this level should not be exceeded. In the event the user overfills the tank, the excess lubricant will be expelled through vent holes located under the lid.

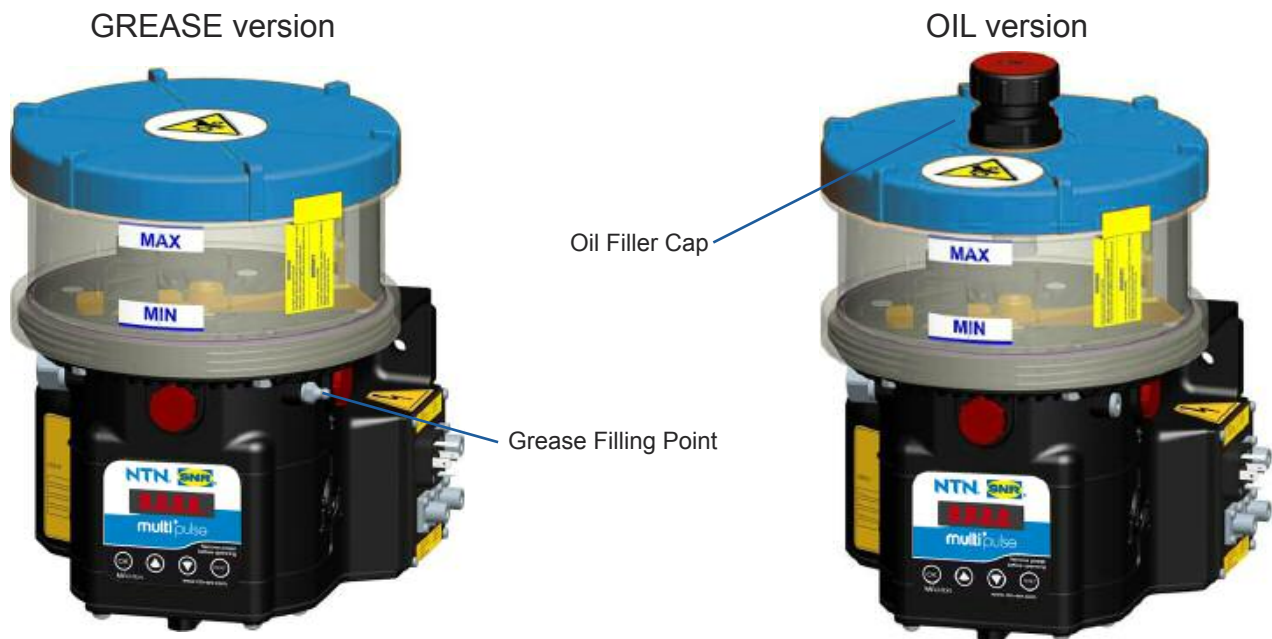

WARNING: To avoid introducing contamination into the pump and voiding the warranty ensure that refilling is always carried out through the designated ports using clean grease. Refer to 15 for more information about lubricant characteristics.

8.4 CONFIGURATION

Automatic version
Control panel layout



Optional Remote Light Button

The light is constantly lit when the pump is running.

Flashes when a minimum level or other alarm is detected by the control system in the pump. The number of flashes defines the anomaly code.

When pressed during the pause (standby) cycle, it will make the pump starts a lubrication cycle and then return to normal automatic operation. The RESET of the pump is allowed when the button is pressed for 6 seconds.

8.4.1 OPERATING MODE :

The MULTI'PULSE Manual version does not have any adjustable feature as there is no local controller. You should arrange to control the pump ON/OFF with a host system that activates the pump as required and monitors the lubrication system, including checking level switch and cycle switch when installed.

8.4.2 OPERATION MODE – AUTOMATIC VERSION MODE CYCLE

Pump stand by	Pump working	Cycle sensor	ALARM (TIMEOUT)
<p>Exemple 1) Timer based pause and lubrication cycle. [P.Hou ≥ 1; P.Cou = 0; C.Min ≥ 1; C.Cou = 0;]</p>	<p>1 sec. - 99 min.</p>	<p>X</p>	<p>X Only low level</p>
<p>Exemple 2) Timer based pause. Lubrication cycle with monitoring of cycle sensor. [P.Hou ≥ 1; P.Cou = 0; C.Min ≥ 1; C.Cou ≥ 1;]</p>		<p>Ok ?</p> <p>yes ↓</p>	<p>No → STOP</p>
<p>Exemple 3) Pause cycle determined by external impulse. Lubrication cycle monitors cycle sensor. [P.Hou = 0; P.Cou ≥ 1; C.Min ≥ 1; C.Cou ≥ 1;]</p>		<p>Ok ?</p> <p>yes ↓</p>	<p>No → STOP</p>
<p>Exemple 4) Pause determined by either time or extend impulse. [P.Hou ≥ 1; P.Cou ≥ 1; C.Min ≥ 1; C.Cou ≥ 1; PTOA=OFF]</p> <p>Whichever first</p>		<p>Ok ?</p> <p>yes ↓</p>	<p>No → STOP</p>
<p>Exemple 5) Pause determined by extend impulse, pause time generates alarm if impulses not received. [P.Hou ≥ 1; P.Cou ≥ 1; C.Min ≥ 1; C.Cou ≥ 1; PTOA=ON]</p>		<p>Ok ?</p> <p>yes ↓</p>	<p>Alarm → STOP</p> <p>No → STOP</p>

8.4.3 OPERATION MODE – AUTOMATIC VERSION MODE PULSE

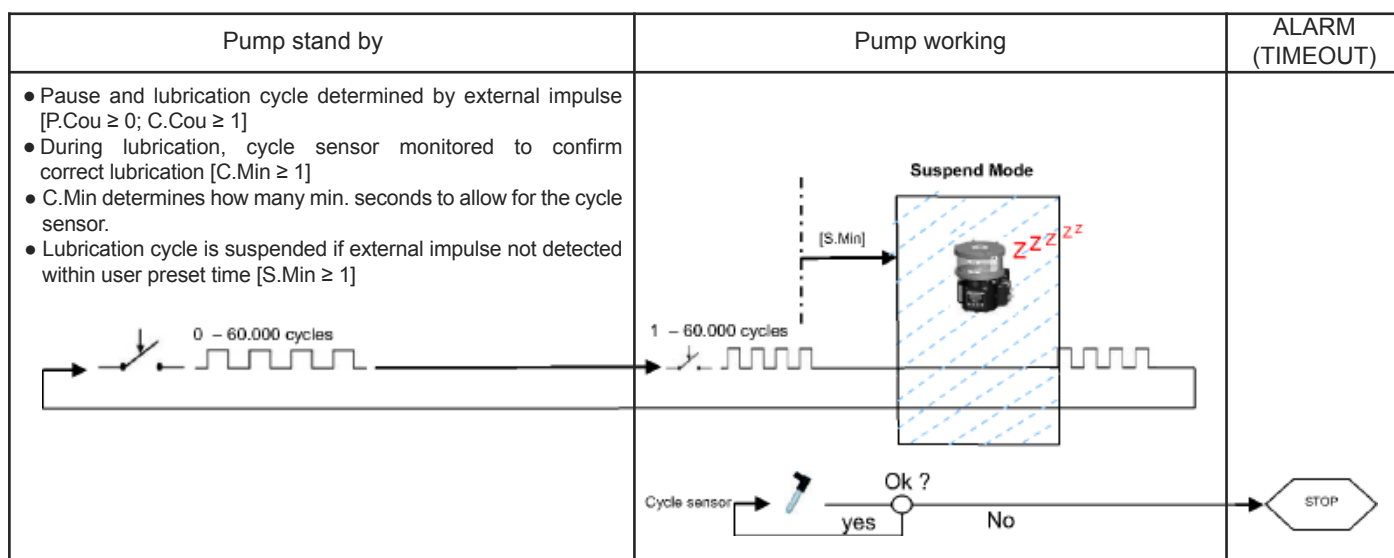

8.4.4 OPERATION MODE – AUTOMATIC VERSION MODE OFF

Pump operates when external signal is given. No monitoring.

NOTE : When power is removed from the Bravo, the electronic control will save the cycle condition in memory. When power is reapplied the controller will resume the logic from exactly the same point (unless the PRELUBE option is set).

When powering on the system or when pressing the RESET button the display will the firmware version of the unit for 2 seconds.











For all modes the Prelube parameter determines if the pump starts in a lubrication cycle when it is set to ON.

Cycle and Pause inputs consider one complete cycle when the input returns to its original state at the time of cycle. For example, if the switch is in the ON state at the start of the lubrication cycle then it must change state to OFF, and then back to ON to count as one cycle.







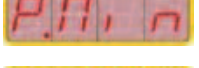
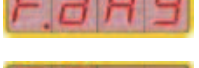
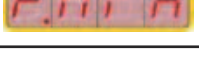



SPECIAL FUNCTIONS AND PARAMETERS		
STEP	BUTTONS	DESCRIPTION
1	hold for 5 seconds	Enter programming mode
2	or	Select PARAMETER to change
3		Confirm the selection and view the current value
4	or	Increment/Decrement VALUE/SETTING of PARAMETER
5		Confirm value/setting and return to menu
6	hold for 2.5 seconds	Save settings and exit programming mode

NOTE : To modify the operating parameters repeats steps 2 to 5 for all necessary values and then follow step 6 to save and exit.

During programming mode, if no button is pressed for 20 seconds, or alternatively UP or DOWN arrows are held for 2.5 seconds, this will exit Programming mode without saving the values.

SPECIAL FUNCTIONS AND PARAMETERS		
BUTTONS	DISPLAY	DESCRIPTION
 +  +  Release 		Reset to default parameters for the current OPERATING MODE
 +  Release 	     	Display total days in working state Display total minutes in working state Display total days in pause state Display total minutes in pause state Display total days in alarm state Display total minutes in alarm state

8.5 PROGRAMMING THE ELECTRICAL CONTROLLER

OPERATING PARAMATERS					
DISPLAY	DESCRIPTION	MODE	DEFAULT	RANGE	NOTES
		CYCLE PULSE OFF			Cyclo 100%
	PAUSE TIMER: SET Hours and Minutes	CYCLE	10 min	0 min / 99 min	Both
	TIMER to suspend the cycle	PULSE	0 sec	0 sec / 99 min	
	PAUSE COUNTER: number of divider switch cycles to wait in pause	CYCLE PULSE	1 cycle	0 / 60000	Compleat cycle
	CYCLE TIMER: if timed cycle it indicates the duration; if cycle with control impulses, indicates the waited maximum time of the single impulse before alarm.	CYCLE PULSE	1 min	99 min / 1 sec	
	CYCLE COUNTER: number of divider switch cycles per lubrication cycle. input used: • Sensor Cycle if Cycle Mode • Sensor Pause if Pulse Mode	CYCLE PULSE	1 cycle	0 / 60000	Compleat cycle
	PRELUBE: Start – controller in Lubrication mode when powered on.	CYCLE PULSE	OFF	ON- OFF	
	Motor DUTY: allows reduction in pump output by adjusting motor speed	CYCLE PULSE OFF	100	100 / 50	
	Number of cycles given from the manual input (it allows eventual filling system)	CYCLE PULSE	1	0 / 9999	
	If OFF, to expiring of the pause time, stars the lubrication cycle. If ON, to expiring of the pause time, gives Pause Time Overrun alarm.	CYCLE	OFF	ON- OFF	

NOTE :

Continuous Cycle: Continuous cycle can be achieved by setting the pause timer to zero.

Complete cycle: Valid on input full cycle ON>OFF>ON or OFF>ON>OFF.







Both: When the pause timer is set to non zero, the system operates in a combined mode.
The cycle will start EITHER on impulse Count OR Pause Time being reached.

9. TROUBLESHOOTING

Below is a trouble shooting table to show possible problems and solutions.

If you are in any doubt about the correct solution to fix a problem, do not dismantle parts of the MULTI'PULSE AC but contact NTN-SNR Experts & Tools for technical assistance.

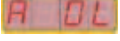
Troubleshooting table		
Problem	Possible cause	Remedial action
Pump Motor does not operate	Power missing	Check the power lines, ensure that any fuse installed is still intact
	Electronic Controller does not function	Replace electronics board
	Gear motor no longer works	Replace gear motor assembly
Pump is operating but no lubricant reaches points	Tubing is disconnected	Check the condition of tubing in the system and ensure that it is correctly secured and not blocked for example, by hardened grease.
	Distributor valves are blocked	Clean or replace.
Lubricant does not reach lubrication points on each pump cycle or irregularly	Distributor valves are incorrectly connected or sized	Check valves and system schematic
	Incorrect Pause/Cycle Settings	Ensure that the system designs and settings allow for at least a full cycle for all distributor valves in the system
No lubricant from pump	Reservoir is empty	Refill, and verify any low level alarms
	Air bubble in grease	Disconnect the primary tubing from the pump and operate a lubrication cycle. Check that clean, air free grease is coming from the pump and then reconnect the tubing.
	Incompatible lubricant.	Some lubricants are not suitable for automatic pumping systems. Replace the grease.
	Blocked pumping element	Dismantle the pumping element and check for contamination. Clean and reinstall or replace.
	Worn pumping element	Replace pumping element
The display is not lit	Incorrect power/voltage	Check power and voltage. Ensure proper power supply to pump.
The pump starts the lubrication cycle but then immediately stops	Defective or blocked Pump motor	Allow the pump to cool. Retry the lubrication cycle. If the problem persists It will be necessary to replace the pump motor assembly.

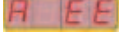
Alarm codes			
Message	Light button	Alarm	Remedy
	1 Flash	Low lubricant level in reservoir	Refill with clean lubricant
	2 Flashes	Cycle Sensor overrun	The cycle sensor was not received within the specified time. Ensure Timer overlong is set to appropriate value and that there is no problem on the lubrication circuit.
	3 Flashes	Pause timer overrun	Verify input pause sensor
	4 Flashes	Pump Motor Blocked	Replace the motor unit
	5 Flashes	Pump Motor Over-load	Allow system to cool, if the problem still goes on go on, replace the motor unit
	6 Flashes	C.CO.U pulses counter in Pulse Mode	Modify C.CO.U parameter
	7 Flashes	Eprom Error	Electronic Board memory error. Board requires replacement

NOTE :

To cancel alarm message push buttons  and  together.

10. MAINTENANCE PROCEDURE

WARNING: Before carrying out any maintenance operation, ensure that power and hydraulic system are disconnected.

The MULTI'PULSE AC pump does not require any special tool for operation and maintenance. When working with the MULTI'PULSE AC pump it is nonetheless recommended that personal health and safety equipment is used as it is normal for any operation in an industrial or similar workplace to best safeguard the user from harm.

The MULTI'PULSE AC pump has been designed and built as to require minimal maintenance and operate in diverse and challenging operating environment. It is recommend that the unit is inspected and kept clean to ensure long life and trouble free operation. It is important to check all tubing on the system to ensure that it is always tight and leak free.

10.1 OPERATIONAL MAINTENANCE

The following operations should be performed on the pump.

Item	Frequency	Operation
Integrity of tubing and system	After initial 500 hours. Every 1500 hours.	Check fittings and tubing secured. Verify components are correctly fixed to machine.
Reservoir level	As needed	Top up level with clean lubricant
Filling Filter	As needed, or once per year	Check and replace as necessary

11. DISPOSAL

During maintenance or disposal of the machine care should be taken to properly dispose of environmentally sensitive items such as oils or other lubricants. Refer to local regulations in force in your area. When disposing of this unit, it is important to ensure that the identification label and all the other relative documents are also destroyed.

12. SPARE PARTS

OPTION

Reference	Description
Lubso pumping element AC	Multipulse fixed flow pump 110/230VAC
Lubso Multipluse AC fixing kit	Kit to assemble the distributor onto the Multipulse AC 110/230V pump
Lubso Multipluse AC tank segment	Tank extension

13. DIMENSIONS

Grease version

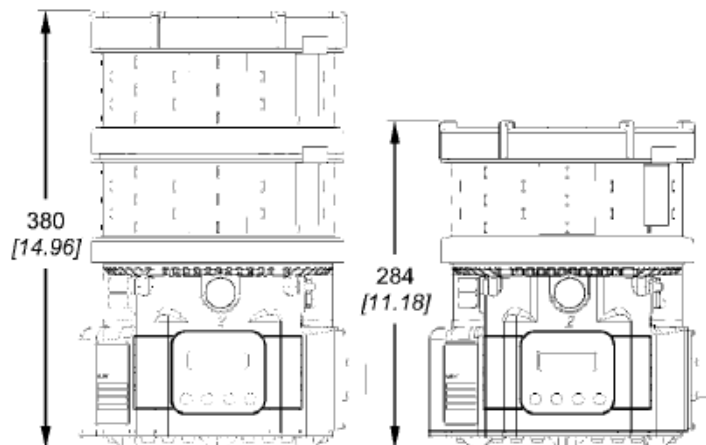

Dimensions in mm [in].

Oil version

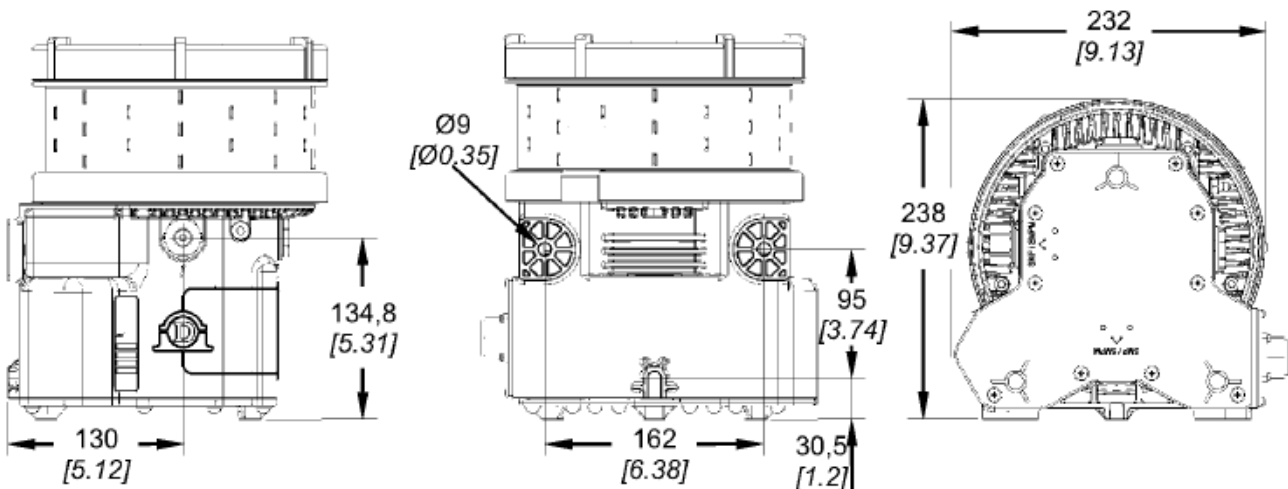

14. HANDLING AND TRANSPORTATION

Prior to shipping, the equipment is carefully packed in cardboard package. During transportation and storage, always maintain the pump the right way up as indicated on the box. On receipt check that package has not been damaged. Then, store the machine in a dry location.

15. OPERATING HAZARDS

WARNING: It is necessary to carefully read the instructions and the risks involved in the use of lubrication machines. The operator must know the machine functioning through the User and Maintenance Manual.

Electric currents

No intervention must be attempted on the equipment without first having disconnected the electrical power supply and ensuring that it cannot be reconnected during the intervention.

All installed equipment, electrical, electronic, tank and base structure, must be connected to the ground line utilizing the terminals fitted to each component.

Flammability

The oil employed in the lubrication circuit is not normally flammable. It is nonetheless indispensable to take every precaution against the oil coming into contact with very hot parts or open flames.

Pressure

Prior to any intervention on the equipment ensure that pressure is released from all branches of the lubrication circuit. Failure to do this could result in oil being discharged under pressure where connections or components are disassembled.

Noise

The MULTI'PULSE AC lubrication panel does not emit excessive noise, remaining below 70dB(A).

WARNING: before carrying out the replacement of the mini-pumps, empty the tank of lubricant.

15.1 LUBRICANTS

NOTE: The pump has been designed to operate with max NLGI 2 grease or min 46cst Oil (oil version). Always use lubricants compatible with NBR (Buna) rubber seals.

Any residual lubricant found on new units is residual NLGI 2 test grease used during the assembly of the pump.

The following table shows the comparison between NLGI (National Lubricating Grease Institute) classification and ASTM (American Society for Testing and Materials) for greases and cSt (Centi stokes) e SUS (Saybolt Universale) for oil.

Grease		Oil	
NLGI	ASTM	cSt	SUS
000	445 - 475	46	213,3
00	400 - 430	70	323
0	355 - 385	100	462,6
1	310 - 340	150	694,2
2	265 - 295	220	1018
For further technical information and on safety information consult the lubricant MSDS Safety data sheet or equivalent document supplied by the lubricant manufacturer.		320	1480
		450	2082
		700	3239
		1000	4628

16. PRECAUTIONS

The verification of conformity with the essential safety requirements and regulations of the Machine Directive is effected by means of the compilation of a check list which has been pre-prepared and is contained in the technical file.

The lists which are utilised are of three types:

- list of dangers (appendix A, EN 1050).
- application of essential safety requirements (Machine Dir. - att. 1, part 1).
- electrical safety requirements (EN 60204).

The following is a list of dangers which have not been fully eliminated but which are considered acceptable:

- During installation there may be low pressure oil coming from the pump. Always use appropriate protective clothing, gloves and take all necessary safety precautions.
- Contact with lubricant during maintenance or filling of the reservoir. □ As per previous point, correct precautions must be taken to protect from contact with lubricant.
- Moving Parts and crush danger : All moving parts are enclosed within the pump unit. Do not open the pump unit. Appropriate danger labels are located on the pump.
- Electric shock : All electrical connections must be carried out by a qualified electrician who has studied the connection to remove electrical danger.
- Abnormal operation posture : The pump should be installed in a suitable position with ample clearance as indicated in this manual to avoid abnormal posture for the operator.
- Unsuitable Lubricant. : Lubricant characteristics are indicated on the pump and in this user manual. In any case contact a NTN-SNR Support engineer.

Fluids explicitly not allowed	
Fluids	Danger
Lubricants with abrasive additives	High wear rate of contacted parts
Lubricants with silicone based additives	Seizure of the pump
Petrol – solvents – inflammable liquids	Fire – explosion – damage to seals
Corrosive products	Corrosion of the pump– injury to persons
Water	Oxidation of the pump
Food substances	Contamination of the substances themselves

17. WARRANTY

All products manufactured and marketed by NTN-SNR Roulements are warranted to be free of defects in material or workmanship for a period of at least 12 months from date of delivery.

Extended warranty coverage applies if complete system installation by NTN-SNR Roulements: 12 Months.

If a fault occurs, notify NTN-SNR giving:

- a complete description of the alleged malfunction
- the part number(s)
- date of delivery
- date of installation
- operating conditions of subject product(s)

We will subsequently review this information and supply you with either servicing data or shipping instruction and returned materials authorization (RMA) which will have instructions on how to prepare the product for return.

NTN - SNR Roulements reserves to right to charge an administration fee if the product(s) returned are found to be not defective. This limited warranty does not cover any products, damages or injuries resulting from misuse, neglect, normal expected wear, chemically caused corrosion, improper installation or operation contrary to factory recommendation. Nor does it cover equipment that has been modified, tampered with or altered without authorization.

Consumables and perishable products are excluded from this or any other warranty.

No other extended liabilities are stated or implied and this warranty in no event covers incidental or consequential damages, injuries or costs resulting from any such defective product(s).

The use of NTN-SNR product(s) implies the acceptance of our warranty conditions. Modifications to our standard warranty must be in made in writing and approved by NTN-SNR Roulements.

18. DECLARATION OF CONFORMITY

DECLARATION OF COMPLIANCE WITH STANDARDS

NTN-SNR Roulements, registered in Annecy, rue des Usines,

CERTIFIES :

that the machine MULTI'PULSE AC pump,
has been constructed in conformity with the DIRECTIVES OF THE COUNCIL OF THE EUROPEAN
COMMUNITY on the standardization of the legislations of member states:

- 2004/108 Electromagnetic compatibility

-- 2006/42 Machinery Directive

- 2006/95 Low voltage

Annecy, July 2010

NTN-SNR Roulements

Christophe Oddoux,
General Manager Experts & Tools

Christophe Benier,
Product Manager Experts & Tools

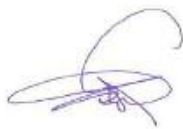

Web site: <http://www.ntn-snr.com> - E-mail: expertsandtools@ntnsnr.com

LUB SOLUTIONS : The Products and Services offer designed to bring you lubrication solutions. Specifically selected for your different applications, a choice of lubricants is offered as well as a full range of reliable systems to dispense them with precision on each mechanical organ.

LUB SOLUTIONS are above all experts to support you while setting up lubrication systems adapted to your environment. From advices to specify your needs to the implementation of your lubrication system, including their manufacturing, rely on our experts to bring you the right solution.

Experts & Tools offer also maintenance tools, specifically designed for bearing fitting and removal.

Should you require more info, please ask for our "Maintenance tool catalogue" or visit our Internet website www.ntn-snr.com



“Bringing you a complete tools and services solution for your bearings, suited to your application, size and resources.”

Experts & Tools 