



KEGELROLLENLAGER

NTN 

Das komplette „2 in 1“ Angebot:
Metrische und zöllige Abmessungen

www.ntn-snr.com



With You

NTN-SNR DIE STÄRKE EINER GRUPPE

NTN-SNR ROULEMENTS ist die europäische Gesellschaft der NTN Corporation - einem der weltweit führenden Wälzlagerhersteller - und ist unter anderem spezialisiert auf die Konstruktion, Entwicklung und Produktion von Kegelrollenlagern.

Als Experte im Product Life Cycle Management zeichnet sich die NTN Corporation durch kurze Reaktionszeiten und hohem Engagement seiner Mitarbeiter aus.

Mit

- einer Produktion von etwa 100 Mio. Kegelrollenlagern jährlich,
- einem umfassenden Angebot in metrischen und zölligen Abmessungen,
- Produktionsstätten in Europa und Japan,
- Versorgungssicherheit für Industriebedarfe,

begleitet Sie NTN-SNR auf dem Weg zu höchster Zuverlässigkeit und Leistungsfähigkeit.

Inhalt

NTN-SNR: unser Angebot für den technischen Handel	1
Lieferprogramm	2
• Metrische Kegelrollenlager	
• Zöllige Kegelrollenlager	
• Wissenswertes über einsatzgehärteten Stahl	
Das Bezeichnungsschema	4
Tabellen mit technischen Daten	5
• So lesen Sie die Tabellen	
• Tabelle der metrischen Abmessungen	
• Index der Abmessungen in Zoll	
• Tabelle der Abmessungen in Zoll	
Dienstleistungen von Experts & Tools	31

NTN-SNR: Unser Angebot für den technischen Handel

Ein zielgerichtetes, einfaches und effizientes Angebot

Um eine hohe Lieferfähigkeit zu garantieren, haben wir die 750 wichtigsten Artikel aus unserem Kegelrollenlagersortiment ausgewählt.

Wie profitieren Sie davon?



„2 in 1“ Angebot

Metrische und zöllige Abmessungen

Ein ausgewähltes Kegelrollenlagersortiment, bestehend aus zwei Produktfamilien und einer Marke (NTN), bildet unser Standardprogramm für den technischen Handel.

- **Entscheiden Sie sich für ein effektives Standardprogramm!**

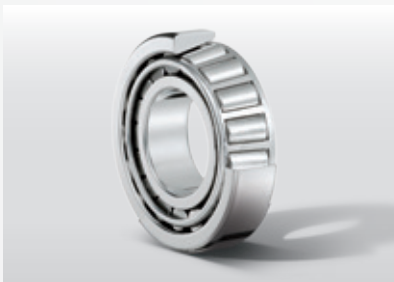

Qualität

Premiumqualität, 100 % Made in Japan

Die zu 100 % in unseren hochmodernen japanischen Werken hergestellten Kegelrollenlager werden regelmäßigen Qualitätsprüfungen unterzogen – von der Fertigung bis zum Transport.

- **Qualität bringt langfristige Sicherheit!**

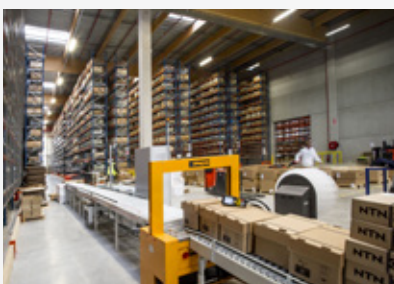

VERFÜGBARKEIT

Garantierte Verfügbarkeit durch europäische Lagerhaltung

100 % der Katalogartikel werden in unserem Lager bevorratet. So gewährleisten wir eine hohe Verfügbarkeit.

- **Wir haben die Produkte vorrätig. Garantiert!**

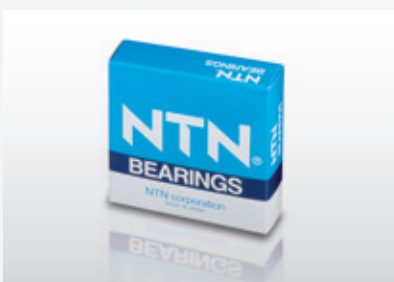

Verpackung

NTN-Markenprodukte

Ihre Produkte werden in den typisch blauen und robusten NTN-Kartonverpackungen geliefert. Ob auf See, Straße oder Schiene: Unsere Verpackungen halten einiges aus.

- **Unsere Produkte kommen sicher an!**

Lieferprogramm

Metrische Kegelrollenlager

BAUREIHE

Das Kegelrollenlagerprogramm besteht aus 10 standardisierten Baureihen.

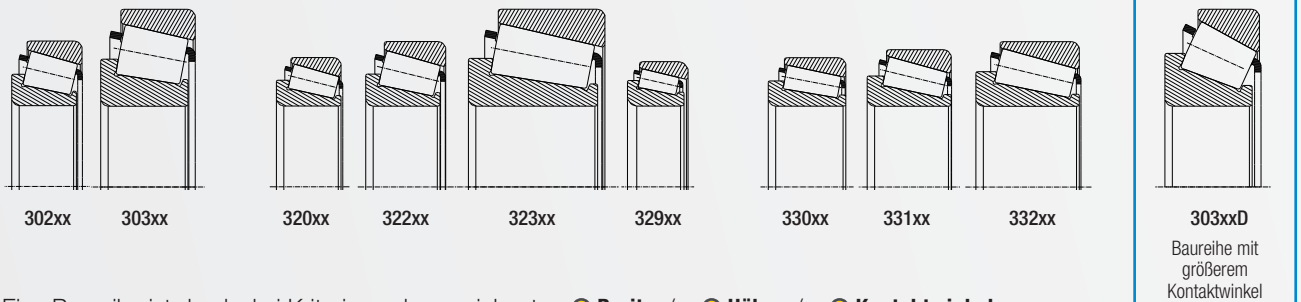

Eine Baureihe ist durch drei Kriterien gekennzeichnet: ● **Breite** / ● **Höhe** / ● **Kontaktwinkel**

Sie ist zudem in unterschiedliche Bohrungsdurchmesser von 20 mm bis 360 mm unterteilt.

Einige Baureihen weisen bis zu 40 unterschiedliche Bohrungsdurchmesser auf!

BEZEICHNUNGEN

Die Bezeichnungen von metrischen NTN-Kegelrollenlagern folgen den ISO-Normen.



Tipp:

Bohrungsdurchmesser, die größer als 20 mm sind, lassen sich berechnen, indem man die letzten beiden Ziffern der Bezeichnung mit 5 multipliziert.

Beispiel:



32212U → 32212 12 X 5 = 60 mm → der Bohrungsdurchmesser beträgt 60 mm

STÄHLE

Für die metrischen Lager kommen zwei Stähle zum Einsatz:

- **einsatzgehärteter Stahl**
- **durchgehärteter Stahl**

Metrisch

Verwendung der Stähle

Durchgehärteter Stahl 60% einsatzgehärteter Stahl 40%

Wissenswertes über einsatzgehärteten Stahl

HOHE LEISTUNG

Unter extremen Einsatzbedingungen und hohen Belastungen weist einsatzgehärteter Stahl **eine 40 % höhere Lebensdauer** im Vergleich zu durchgehärtetem Stahl auf.

+ 40%
höhere Lebensdauer



Zöllige Kegelrollenlager

BAUREIHE

Das Programm mit zölligen Abmessungen umfasst über 20-mal mehr Baureihen als das Programm mit metrischen Abmessungen.

Die Identifikation erfolgt direkt über die Tabelle mit den technischen Daten (siehe Seite 5).



Hinweis: Die metrische J-Baureihe weicht davon ab: Die Bezeichnungen dieser Baureihe sind von den Bezeichnungen mit zölligen Abmessungen abgeleitet. Ihre Außenmaße werden aber in Millimetern angegeben.

Beispiel: JLM104948 / JLM104910 (d = 50 mm, D = 82 mm und T = 21,5 mm).

BEZEICHNUNGEN

NTN folgt bei der Bezeichnung seiner Kegelrollenlager mit zölligen Abmessungen den **ABMA-Normen** (American Bearing Manufacturing Association). Die Bezeichnungen entsprechen somit denen von anderen Herstellern.



Links vom Querstrich „/“:

Bezeichnung für den Konus 'Cone' (Lagerinnenring, Käfig und Rollen)



Tip:

Die Artikelnummern bestehen aus 2 Teilen

Beispiel für eine Artikelnummer:

HH224335 / HH224310



Rechts vom Querstrich „/“:

Bezeichnung für den Lageraußenring 'Cup'

STÄHLE

100 % unserer Kegelrollenlager mit Zollabmessungen bestehen aus einsatzgehärtetem Stahl.

Verwendung der Stähle

Zoll **Einsatzgehärteter Stahl 100 %**

EINDEUTIG IDENTIFIZIERBAR

Alle unsere Kegelrollenlager aus einsatzgehärtetem Stahl sind am Vorsetzzeichen **4T-** erkennbar.

Bei diesen Lagern werden alle Lagerkomponenten aus einsatzgehärtetem Stahl gefertigt:

- Lagerinnenring
- Lageraußenring
- Wälzkörper

Querschnitt eines Lagers aus einsatzgehärtetem Stahl



Gehärtete Oberfläche für höheren Verschleißwiderstand

Zäher Kern zur Aufnahme von Stoßbelastungen

Erläuterung der Bezeichnungen

"Alle Typbezeichnungen in diesem Katalog sind mit denen unserer Wettbewerber vergleichbar.

Die Vor- und Nachsetzzeichen der Bezeichnungen können allerdings von Hersteller zu Hersteller abweichen."

	VORSETZZEICHEN	NACHSETZZEICHEN	BESCHREIBUNG
Metrisch	4T-		Einsatzgehärteter Stahl
		U	Durchgehärteter Stahl
		X	Nachsetzzeichen gemäß ISO-Bezeichnung, Innenring 'Cone' Breite B = Gesamtbreite T
		D	Erhöhter Kontaktwinkel, europäische Baureihe 313xx = 303xxD
		E1	Spezielles, optimiertes Rollenprofil
Zoll		V1, V2, V3, V4	Besondere Spezifikation mit optimiertem Profil
		PX1, PX2	Spezielle Toleranz
		PK	Spezielle Toleranzklasse K für J -Baureihe



Tipp:

Wenn Sie nicht sicher sind, ob die Nummern übereinstimmen, schauen Sie unter „vereinfachte Bezeichnung“ in den Datentabellen nach oder überprüfen Sie die Bezeichnung anhand unseres Online-Tools im e-Shop. Den Zugriff darauf erhalten Sie über den Link oder den QR-Code.



<https://eshop.ntn-snr.com/de/Industrie-12078.html>



Tabellen mit technischen Daten

So lesen Sie die Tabellen

1. Bohrungsdurchmesser

Anordnung in der Tabelle nach aufsteigendem Innendurchmesser.

2. Artikelbezeichnung

Vereinfachte Bezeichnung und standardmäßige Entsprechung von NTN.

3. Abmessungen

Die Maße für die verschiedenen Abmessungen in mm zusammen mit dem Gewicht in Kilogramm.

4. Tragzahl und Drehzahl

Angabe der Tragzahlen in kN und der Drehzahlgrenzen in U/min.

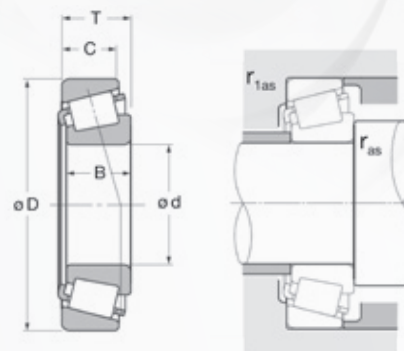
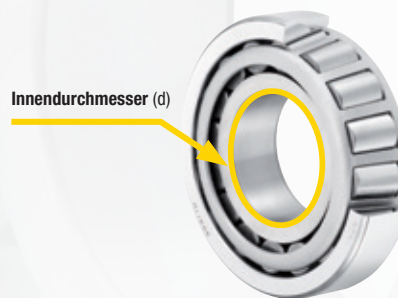

Die vereinfachte europäische Bezeichnung und die entsprechende NTN-Bezeichnung.

Die dynamische und die statische Tragzahl gemäß ISO-Norm. Angaben ohne „Booster“-Koeffizienten.

Bohrungsdurchmesser		Bezeichnung		Abmessungen					Tragzahlen und Drehzahlgrenzen				
Innendurchmesser	Vereinfachte Bezeichnung	NTN-Bezeichnung	Außendurchmesser	Innenringbreite	Außenringbreite	Gesamtbreite	Max. Radius an der Welle	Max. Radius am Gehäuse	Gewicht	Dynamische Tragzahl C	Statische Tragzahl C0	Grenzdrehzahl mit Fett	Grenzdrehzahl mit Öl
(d)			(D)	(B)	(C)	(T)	(r_{as} max)	(r_{1as} max)	kg	kN		U/min	
mm			mm										
17	30303	4T-30303	47	14	12,00	15,25	1,0	1,0	0,134	28,90	26,30	9000	12000



Tipp:

Um eine Bezeichnung mit zölligen Abmessungen einfacher zu finden, verwenden Sie den Index auf den Seiten 12 bis 15. Hier sind die Bezeichnungen in alphanumerischer Reihenfolge zusammen mit der entsprechenden Seite mit der Angabe der technischen Daten aufgeführt.

Bezeichnung mit Bohrungsdurchmesser

4		
Bezeichnung	d (mm)	s.
41125/41286	28,575	17
418/414	38,100	19
42350/42584	88,900	27
42375/42584	95,250	27
42381/42584	96,838	27
42687/42620	76,200	26
42690/42620	77,788	26
43125/43312	91,750	18

Erstes Zeichen (Buchstabe oder Ziffer) der Bezeichnung

Seite mit vollständigen technischen Daten

Metrische Abmessungen

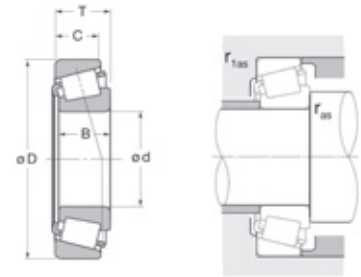

Innendurchmesser (d) mm	Vereinfachte Bezeichnung	NTN-Bezeichnung	Außendurchmesser	Innenringbreite	Außenringbreite	Gesamtbreite	Max. Radius an der Welle	Max. Radius am Gehäuse	Gewicht	Dynamische Tragzahl C	Statische Tragzahl C ₀	Grenzdrehzahl mit Fett	Grenzdrehzahl mit Öl
			(D)	(B)	(C)	(T)	(r _{as max})	(r _{ias max})					
			mm						kg	kN		U/min	
15	30202	30202	35	11	10,00	11,75	1,0	1,0	0,053	13,40	12,30	11000	15000
	30302	4T-30302	42	13	11,00	14,25	1,0	1,0	0,098	23,20	20,80	9900	13000
17	30203	4T-30203	40	12	11,00	13,25	1,0	1,0	0,080	20,50	20,30	9900	13000
	30303	4T-30303	47	14	12,00	15,25	1,0	1,0	0,134	28,90	26,30	9000	12000
20	32004	4T-32004X	42	15	12,00	15,00	0,6	0,6	0,097	24,90	27,90	9500	13000
	30204	4T-30204	47	14	12,00	15,25	1,0	1,0	0,127	28,20	28,70	8800	12000
	32204	4T-32204	47	18	15,00	19,25	1,0	1,0	0,160	36,50	39,50	8800	12000
	30304	4T-30304	52	16	13,00	16,25	1,5	1,5	0,169	35,50	34,00	8000	11000
	32304	4T-32304	52	21	18,00	22,25	1,5	1,5	0,245	46,50	48,50	8000	11000
22	320/22	4T-320/22X	44	15	11,50	15,00	0,6	0,6	0,106	27,00	31,50	8900	12000
25	32005	4T-32005X	47	15	11,50	15,00	0,6	0,6	0,114	27,80	33,50	7900	11000
	33005	4T-33005	47	17	14,00	17,00	0,6	0,6	0,130	32,50	40,50	8000	11000
	30205	4T-30205	52	15	13,00	16,25	1,0	1,0	0,154	31,50	34,00	7300	9800
	32205	4T-32205	52	18	16,00	19,25	1,0	1,0	0,181	38,00	43,00	7300	9800
	33205	4T-33205	52	22	18,00	22,00	1,0	1,0	0,217	47,50	57,50	7300	9800
	31305	4T-30305D	62	17	13,00	18,25	1,5	1,5	0,284	40,50	43,50	5900	7800
	30305	4T-30305	62	17	15,00	18,25	1,5	1,5	0,272	48,50	47,50	6700	8900
	32305	4T-32305	62	24	20,00	25,25	1,5	1,5	0,381	61,50	64,50	6700	8900
28	320/28	4T-320/28X	52	16	12,00	16,00	1,0	1,0	0,146	33,00	40,50	7300	9700
	302/28	4T-302/28	58	16	14,00	17,25	1,0	1,0	0,202	42,00	44,50	6700	8900
30	32006	4T-32006X	55	17	13,00	17,00	1,0	1,0	0,166	37,50	46,00	6900	9200
	33006	4T-33006	55	20	16,00	20,00	1,0	1,0	0,201	42,50	54,00	6900	9200
	30206	4T-30206	62	16	14,00	17,25	1,0	1,0	0,241	43,50	48,00	6300	8400
	32206	4T-32206	62	20	17,00	21,25	1,0	1,0	0,301	54,50	64,00	6300	8400
	33206	4T-33206	62	25	19,50	25,00	1,0	1,0	0,344	65,00	77,00	6300	8400
	31306	4T-30306D	72	19	14,00	20,75	1,5	1,5	0,398	48,50	51,50	5000	6700
	30306	4T-30306	72	19	16,00	20,75	1,5	1,5	0,408	60,00	61,00	5700	7600
	32306	4T-32306	72	27	23,00	28,75	1,5	1,5	0,583	81,00	90,00	5700	7600
32	320/32	4T-320/32X	58	17	13,00	17,00	1,0	1,0	0,181	37,00	46,50	6600	8700
	302/32	302/32	65	17	15,00	18,25	1,0	1,0	0,258	41,50	44,00	6000	8000
35	32007	4T-32007X	62	18	14,00	18,00	1,0	1,0	0,224	41,50	52,50	6100	8100
	30207	4T-30207	72	17	15,00	18,25	1,5	1,5	0,344	55,50	61,50	5500	7400
	32207	4T-32207	72	23	19,00	24,25	1,5	1,5	0,457	72,50	87,00	5500	7400
	33207	4T-33207	72	28	22,00	28,00	1,5	1,5	0,531	87,50	109,00	5500	7400
	31307	4T-30307D	80	21	15,00	22,75	2,0	1,5	0,530	63,50	70,00	4400	5800
	30307	4T-30307	80	21	18,00	22,75	2,0	1,5	0,540	75,00	77,00	5000	6600
	32307	4T-32307	80	31	25,00	32,75	2,0	1,5	0,787	101,00	115,00	5000	6600

Metrische Abmessungen

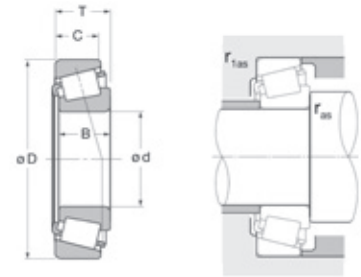

Innendurchmesser (d) mm	Vereinfachte Bezeichnung	NTN-Bezeichnung	Außendurchmesser	Innenringbreite	Außenringbreite	Gesamtbreite	Max. Radius an der Welle	Max. Radius am Gehäuse	Gewicht	Dynamische Tragzahl C	Statische Tragzahl C0	Grenzdrehzahl mit Fett	Grenzdrehzahl mit Öl
			(D)	(B)	(C)	(T)	(r _{as max})	(r _{as max})					
			mm										
40	32008	4T-32008X	68	19	14,50	19,00	1,0	1,0	0,273	50,00	65,50	5300	7100
	33008	4T-33008	68	22	18,00	22,00	1,0	1,0	0,312	59,50	82,50	5300	7100
	30208	4T-30208	80	18	16,00	19,75	1,5	1,5	0,435	61,00	67,00	4900	6600
	32208	4T-32208	80	23	19,00	24,75	1,5	1,5	0,558	79,50	93,50	4900	6600
	33208	4T-33208	80	32	25,00	32,00	1,5	1,5	0,728	103,00	132,00	4900	6600
	31308	4T-30308D	90	23	17,00	25,25	2,0	1,5	0,738	77,00	85,50	3900	5200
	30308	4T-30308	90	23	20,00	25,25	2,0	1,5	0,769	91,50	102,00	4400	5900
	32308	4T-32308	90	33	27,00	35,25	2,0	1,5	1,080	122,00	150,00	4400	5900
45	32009	4T-32009X	75	20	15,50	20,00	1,0	1,0	0,346	57,50	76,50	4800	6400
	33109	4T-33109	80	26	20,50	26,00	1,5	1,5	0,542	84,50	115,00	4700	6200
	30209	4T-30209	85	19	16,00	20,75	1,5	1,5	0,495	67,50	78,50	4400	5900
	32209	4T-32209	85	23	19,00	24,75	1,5	1,5	0,607	82,00	100,00	4400	5900
	33209	4T-33209	85	32	25,00	32,00	1,5	1,5	0,783	107,00	141,00	4400	5900
	31309	4T-30309D	100	25	18,00	27,25	2,0	1,5	0,958	96,00	109,00	3500	4600
	30309	4T-30309	100	25	22,00	27,25	2,0	1,5	1,010	111,00	126,00	4000	5300
	32309	32309U	100	36	30,00	38,25	2,0	1,5	1,460	154,00	191,00	4000	5300
50	32910	32910XU	72	15	12,00	15,00	0,6	0,6	0,191	35,50	57,00	4700	6300
	32010	4T-32010X	80	20	15,50	20,00	1,0	1,0	0,366	62,50	88,00	4400	5800
	33010	4T-33010	80	24	19,00	24,00	1,0	1,0	0,433	69,50	103,00	4400	5800
	33110	4T-33110	85	26	20,00	26,00	1,5	1,5	0,580	86,50	121,00	4200	5600
	30210	4T-30210	90	20	17,00	21,75	1,5	1,5	0,563	77,00	93,00	4000	5300
	32210	4T-32210	90	23	19,00	24,75	1,5	1,5	0,648	87,50	109,00	4000	5300
	33210	4T-33210	90	32	24,50	32,00	1,5	1,5	0,852	115,00	158,00	4000	5300
	31310	4T-30310D	110	27	19,00	29,25	2,0	2,0	1,250	113,00	130,00	3200	4200
	30310	4T-30310	110	27	23,00	29,25	2,0	2,0	1,310	133,00	152,00	3600	4800
	32310	32310U	110	40	33,00	42,25	2,0	2,0	1,920	184,00	232,00	3600	4800
55	32911	32911XU	80	17	14,00	17,00	1,0	1,0	0,274	44,50	73,50	4300	5700
	32011	4T-32011X	90	23	17,50	23,00	1,5	1,5	0,563	80,50	118,00	4000	5400
	33011	4T-33011	90	27	21,00	27,00	1,5	1,5	0,643	91,50	138,00	4000	5400
	33111	4T-33111	95	30	23,00	30,00	1,5	1,5	0,846	111,00	155,00	3900	5200
	30211	4T-30211	100	21	18,00	22,75	2,0	1,5	0,740	93,00	111,00	3600	4900
	32211	4T-32211	100	25	21,00	26,75	2,0	1,5	0,876	108,00	134,00	3600	4900
	33211	4T-33211	100	35	27,00	35,00	2,0	1,5	1,150	138,00	188,00	3600	4900
	31311	4T-30311D	120	29	21,00	31,50	2,0	2,0	1,590	132,00	154,00	2900	3800
	30311	4T-30311	120	29	25,00	31,50	2,0	2,0	1,660	155,00	179,00	3300	4400
	32311	32311U	120	43	35,00	45,50	2,0	2,0	2,440	215,00	275,00	3300	4400

Metrische Abmessungen

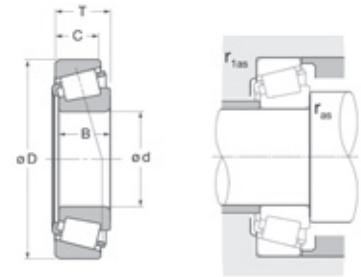

Innendurchmesser (d) mm	Vereinfachte Bezeichnung	NTN-Bezeichnung	Außendurchmesser	Innenringbreite	Außenringbreite	Gesamtbreite	Max. Radius an der Welle	Max. Radius am Gehäuse	Gewicht	Dynamische Tragzahl C	Statische Tragzahl C0	Grenzdrehzahl mit Fett	Grenzdrehzahl mit Öl
			(D)	(B)	(C)	(T)	(r _{as max})	(r _{1as max})					
60	32912	32912XA	85	17	14,00	17,00	1,0	1,0	0,295	51,00	83,00	4000	5300
	32012	32012XU	95	23	17,50	23,00	1,5	1,5	0,576	82,00	123,00	3700	4900
	33012	4T-33012	95	27	21,00	27,00	1,5	1,5	0,684	93,50	145,00	3700	4900
	33112	33112U	100	30	23,00	30,00	1,5	1,5	0,912	113,00	164,00	3600	4700
	30212	4T-30212	110	22	19,00	23,75	2,0	1,5	0,949	105,00	125,00	3400	4500
	32212	32212U	110	28	24,00	29,75	2,0	1,5	1,180	130,00	164,00	3400	4500
	33212	33212U	110	38	29,00	38,00	2,0	1,5	1,550	161,00	223,00	3400	4500
	31312	4T-30312D	130	31	22,00	33,50	2,5	2,0	1,970	150,00	176,00	2700	3600
	30312	30312U	130	31	26,00	33,50	2,5	2,0	2,060	180,00	210,00	3000	4000
	32312	32312U	130	46	37,00	48,50	2,5	2,0	3,020	244,00	315,00	3000	4000
65	32913	32913XU	90	17	14,00	17,00	1,0	1,0	0,315	48,50	85,00	3700	4900
	32013	32013XU	100	23	17,50	23,00	1,5	1,5	0,630	83,00	128,00	3400	4600
	33013	4T-33013	100	27	21,00	27,00	1,5	1,5	0,732	97,50	156,00	3400	4600
	33113	4T-33113	110	34	26,50	34,00	1,5	1,5	1,280	144,00	211,00	3300	4400
	30213	4T-30213	120	23	20,00	24,75	2,0	1,5	1,180	123,00	148,00	3100	4200
	32213	32213U	120	31	27,00	32,75	2,0	1,5	1,580	159,00	206,00	3100	4200
	33213	33213U	120	41	32,00	41,00	2,0	1,5	1,980	195,00	265,00	3100	4200
	31313	4T-30313D	140	33	23,00	36,00	2,5	2,0	2,420	173,00	204,00	2500	3300
	30313	30313U	140	33	28,00	36,00	2,5	2,0	2,550	203,00	238,00	2800	3700
	32313	32313U	140	48	39,00	51,00	2,5	2,0	3,660	273,00	350,00	2800	3700
70	32914	32914XU	100	20	16,00	20,00	1,0	1,0	0,487	68,50	110,00	3400	4600
	32014	32014XU	110	25	19,00	25,00	1,5	1,5	0,848	105,00	160,00	3200	4200
	33014	33014U	110	31	25,50	31,00	1,5	1,5	1,070	127,00	204,00	3200	4200
	33114	33114U	120	37	29,00	37,00	2,0	1,5	1,676	171,00	251,00	3100	4100
	30214	30214U	125	24	21,00	26,25	2,0	1,5	1,260	131,00	162,00	2900	3900
	32214	32214U	125	31	27,00	33,25	2,0	1,5	1,680	166,00	220,00	2900	3900
	33214	33214U	125	41	32,00	41,00	2,0	1,5	2,100	201,00	282,00	2900	3900
	31314	4T-30314D	150	35	25,00	38,00	2,5	2,0	2,920	193,00	229,00	2300	3000
	30314	30314U	150	35	30,00	38,00	2,5	2,0	3,060	230,00	272,00	2600	3500
	32314	32314U	150	51	42,00	54,00	2,5	2,0	4,460	310,00	405,00	2600	3500
75	32915	32915XU	105	20	16,00	20,00	1,0	1,0	0,511	69,50	114,00	3200	4300
	32015	32015XU	115	25	19,00	25,00	1,5	1,5	0,909	106,00	167,00	3000	4000
	33015	33015U	115	31	25,50	31,00	1,5	1,5	1,110	111,00	186,00	3000	4000
	33115	4T-33115	125	37	29,00	37,00	2,0	1,5	1,741	170,00	252,00	2900	3800
	30215	4T-30215	130	25	22,00	27,25	2,0	1,5	1,410	139,00	175,00	2700	3600
	32215	32215U	130	31	27,00	33,25	2,0	1,5	1,740	168,00	224,00	2700	3600
	33215	33215U	130	41	31,00	41,00	2,0	1,5	2,200	208,00	298,00	2700	3600
	31315	30315DU	160	37	26,00	40,00	2,5	2,0	3,470	215,00	256,00	2100	2800
	30315	30315U	160	37	31,00	40,00	2,5	2,0	3,570	255,00	305,00	2400	3200
	32315	32315U	160	55	45,00	58,00	2,5	2,0	5,350	355,00	470,00	2400	3200

Metrische Abmessungen

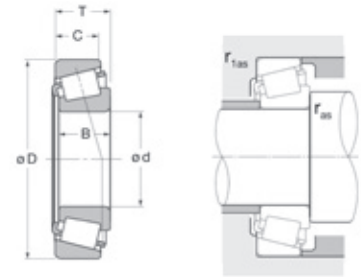

Innendurchmesser (d) mm	Vereinfachte Bezeichnung	NTN-Bezeichnung	Außendurchmesser (D)	Innenringbreite (B)	Außenringbreite (C)	Gesamtbreite (T)	Max. Radius an der Welle (r _{as max})	Max. Radius am Gehäuse (r _{1as max})	Gewicht (kg)	Dynamische Tragzahl C (kN)	Statische Tragzahl C0 (kN)	Grenzdrehzahl mit Fett (U/min)	Grenzdrehzahl mit Öl (U/min)
			mm										
80	32916	32916XU	110	20	16,00	20,00	1,0	1,0	0,540	72,00	121,00	3000	4000
	32016	32016XU	125	29	22,00	29,00	1,5	1,5	1,280	139,00	216,00	2800	3700
	33016	33016U	125	36	29,50	36,00	1,5	1,5	1,600	173,00	284,00	2800	3700
	33116	33116U	130	37	29,00	37,00	2,0	1,5	1,862	179,00	276,00	2700	3600
	30216	30216U	140	26	22,00	28,25	2,0	2,0	1,720	160,00	200,00	2500	3400
	32216	32216U	140	33	28,00	35,25	2,0	2,0	2,180	199,00	265,00	2500	3400
	33216	33216U	140	46	35,00	46,00	2,0	2,0	2,920	250,00	365,00	2500	3400
	31316	30316DU	170	39	27,00	42,50	2,5	2,0	4,110	236,00	283,00	2000	2700
	30316	30316U	170	39	33,00	42,50	2,5	2,0	4,410	291,00	350,00	2300	3000
	32316	32316U	170	58	48,00	61,50	2,5	2,0	6,410	395,00	525,00	2300	3000
85	32917	32917XU	120	23	18,00	23,00	1,5	1,5	0,773	94,00	157,00	2800	3800
	32017	32017XU	130	29	22,00	29,00	1,5	1,5	1,350	142,00	224,00	2600	3500
	33017	33017U	130	36	29,50	36,00	1,5	1,5	1,700	176,00	296,00	2600	3500
	33117	33117U	140	41	32,00	41,00	2,0	2,0	2,440	211,00	330,00	2500	3400
	30217	30217U	150	28	24,00	30,50	2,0	2,0	2,140	183,00	232,00	2400	3200
	32217	32217U	150	36	30,00	38,50	2,0	2,0	2,750	224,00	300,00	2400	3200
	33217	33217U	150	49	37,00	49,00	2,0	2,0	3,580	284,00	420,00	2400	3200
	31317	30317DU	180	41	28,00	44,50	3,0	2,5	4,850	247,00	293,00	1900	2500
	30317	30317U	180	41	34,00	44,50	3,0	2,5	5,200	305,00	365,00	2100	2900
	32317	32317U	180	60	49,00	63,50	3,0	2,5	7,150	405,00	525,00	2100	2900
90	32918	32918XU	125	23	18,00	23,00	1,5	1,5	0,817	97,50	168,00	2700	3600
	32018	32018XU	140	32	24,00	32,00	2,0	1,5	1,790	168,00	270,00	2500	3300
	33018	33018U	140	39	32,50	39,00	2,0	1,5	2,180	215,00	360,00	2500	3300
	33118	33118U	150	45	35,00	45,00	2,0	2,0	3,099	253,00	400,00	2400	3200
	30218	30218U	160	30	26,00	32,50	2,0	2,0	2,660	208,00	267,00	2200	3000
	32218	32218U	160	40	34,00	42,50	2,0	2,0	3,490	262,00	360,00	2200	3000
	33218	33218U	160	55	42,00	55,00	2,0	2,0	4,609	325,00	490,00	2200	3000
	31318	30318DU	190	43	30,00	46,50	3,0	2,5	5,660	270,00	320,00	1800	2400
	30318	30318U	190	43	36,00	46,50	3,0	2,5	6,030	335,00	405,00	2000	2700
	32318	32318U	190	64	53,00	67,50	3,0	2,5	8,570	450,00	595,00	2000	2700
95	32919	32919XU	130	23	18,00	23,00	1,5	1,5	0,851	101,00	178,00	2500	3400
	32019	32019XU	145	32	24,00	32,00	2,0	1,5	1,830	171,00	280,00	2300	3100
	33019	4T-33019	145	39	32,50	39,00	2,0	1,5	2,270	219,00	375,00	2300	3100
	30219	30219U	170	32	27,00	34,50	2,5	2,0	3,070	226,00	290,00	2100	2800
	32219	32219U	170	43	37,00	45,50	2,5	2,0	4,300	299,00	415,00	2100	2800
	31319	30319DU	200	45	32,00	49,50	3,0	2,5	6,470	296,00	355,00	1700	2200
	30319	30319U	200	45	38,00	49,50	3,0	2,5	6,980	365,00	445,00	1900	2500
	32319	32319U	200	67	55,00	71,50	3,0	2,5	10,100	505,00	670,00	1900	2500

Metrische Abmessungen

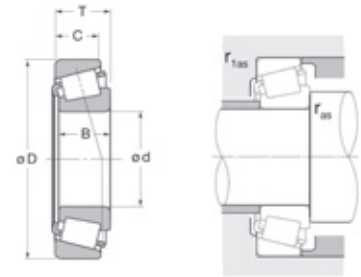

Innendurchmesser	Vereinfachte Bezeichnung	NTN-Bezeichnung	Außendurchmesser	Innenringbreite	Außenringbreite	Gesamtbreite	Max. Radius an der Welle	Max. Radius am Gehäuse	Gewicht	Dynamische Tragzahl C	Statische Tragzahl C0	Grenzdrehzahl mit Fett	Grenzdrehzahl mit Öl
(d)			(D)	(B)	(C)	(T)	(r _{as} max)	(r _{ias} max)	kg	kN		U/min	
mm			mm						kg	kN		U/min	
100	32920	32920XU	140	25	20,00	25,00	1,5	1,5	1,140	121,00	206,00	2400	3200
	32020	32020XU	150	32	24,00	32,00	2,0	1,5	1,910	170,00	281,00	2200	3000
	33020	33020U	150	39	32,50	39,00	2,0	1,5	2,370	224,00	390,00	2200	3000
	30220	30220U	180	34	29,00	37,00	2,5	2,0	3,780	258,00	335,00	2000	2700
	32220	32220U	180	46	39,00	49,00	2,5	2,0	5,120	330,00	465,00	2000	2700
	33220	33220U	180	63	48,00	63,00	2,5	2,0	6,746	415,00	650,00	2000	2700
	30320	30320U	215	47	39,00	51,50	3,0	2,5	8,560	410,00	500,00	1800	2400
	31320	31320XU	215	51	35,00	56,50	3,0	2,5	8,670	355,00	435,00	1800	2400
	32320	32320U	215	73	60,00	77,50	3,0	2,5	12,700	570,00	770,00	1800	2400
105	32921	32921XA	145	25	20,00	25,00	1,5	1,5	1,192	126,00	219,00	2300	3000
	32021	32021XU	160	35	26,00	35,00	2,0	2,0	2,420	201,00	335,00	2100	2800
	33021	33021U	160	43	34,00	43,00	2,0	2,0	3,000	245,00	420,00	2100	2800
	30221	30221U	190	36	30,00	39,00	2,5	2,0	4,390	287,00	380,00	1900	2500
	32221	32221U	190	50	43,00	53,00	2,5	2,0	6,250	380,00	540,00	1900	2500
	30321	30321U	225	49	41,00	53,50	3,0	2,5	9,790	435,00	530,00	1700	2300
	32321	32321U	225	77	63,00	81,50	3,0	2,5	14,500	610,00	825,00	1700	2300
110	32922	32922XA	150	25	20,00	25,00	1,5	1,5	1,240	127,00	226,00	2200	2900
	32022	32022XU	170	38	29,00	38,00	2,0	2,0	3,070	236,00	390,00	2000	2700
	33022	33022U	170	47	37,00	47,00	2,0	2,0	3,800	288,00	500,00	2000	2700
	33122	33122UE1	180	56	43,00	56,00	2,0	2,0	5,518	360,00	610,00	1900	2600
	30222	30222U	200	38	32,00	41,00	2,5	2,0	5,180	325,00	435,00	1800	2400
	32222	32222U	200	53	46,00	56,00	2,5	2,0	7,430	420,00	605,00	1800	2400
	30322	30322U	240	50	42,00	54,50	3,0	2,5	11,400	480,00	590,00	1600	2200
	32322	32322U	240	80	65,00	84,50	3,0	2,5	18,000	705,00	970,00	1600	2200
120	32924	32924	165	29	23,00	29,00	1,5	1,5	1,770	162,00	294,00	2000	2600
	32024	32024XU	180	38	29,00	38,00	2,0	2,0	3,250	245,00	420,00	1800	2500
	33024	33024U	180	48	38,00	48,00	2,0	2,0	4,140	293,00	520,00	1800	2500
	30224	30224U	215	40	34,00	43,50	2,5	2,0	6,230	345,00	470,00	1700	2200
	32224	32224U	215	58	50,00	61,50	2,5	2,0	9,080	460,00	680,00	1700	2200
	30324	30324U	260	55	46,00	59,50	3,0	2,5	14,200	560,00	695,00	1500	2000
	32324	32324U	260	86	69,00	90,50	3,0	2,5	22,400	815,00	1130,00	1500	2000
130	32926	32926	180	30	26,00	32,00	2,0	2,0	2,240	142,00	252,00	1800	2400
	32026	32026XU	200	45	34,00	45,00	2,0	2,0	4,960	320,00	545,00	1700	2200
	30226	30226U	230	40	34,00	43,75	3,0	2,5	7,250	375,00	505,00	1500	2000
	32226	32226U	230	64	54,00	67,75	3,0	2,5	11,200	530,00	815,00	1500	2000
	30326	30326U	280	58	49,00	63,75	4,0	3,0	17,400	650,00	830,00	1400	1800
140	32928	32928XU	190	32	25,00	32,00	2,0	1,5	2,510	200,00	375,00	1700	2200
	32028	32028XU	210	45	34,00	45,00	2,0	2,0	5,280	330,00	580,00	1600	2100
	33028	33028U	210	56	44,00	56,00	2,0	2,0	6,580	390,00	715,00	1600	2100
	30228	30228U	250	42	36,00	45,75	3,0	2,5	9,260	420,00	570,00	1400	1900
	32228	32228U	250	68	58,00	71,75	3,0	2,5	14,100	610,00	920,00	1400	1900
	30328	30328U	300	62	53,00	67,75	4,0	3,0	21,200	735,00	950,00	1300	1700

Metrische Abmessungen

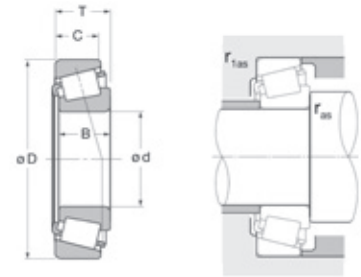

Innendurchmesser (d) mm	Vereinfachte Bezeichnung	NTN-Bezeichnung	Außendurchmesser	Innenringbreite	Außenringbreite	Gesamtbreite	Max. Radius an der Welle	Max. Radius am Gehäuse	Gewicht	Dynamische Tragzahl C	Statische Tragzahl C0	Grenzdrehzahl mit Fett	Grenzdrehzahl mit Öl
			(D)	(B)	(C)	(T)	($r_{as \max}$)	($r_{1as \max}$)					
			mm						kg	kN		U/min	
150	32930	32930XU	210	38	30,00	38,00	2,0	2,0	3,920	268,00	490,00	1600	2100
	32030	32030XU	225	48	36,00	48,00	2,5	2,0	6,370	370,00	655,00	1400	1900
	33030	4T-33030	225	59	46,00	59,00	2,5	2,0	8,070	460,00	860,00	1400	1900
	30230	30230U	270	45	38,00	49,00	3,0	2,5	11,200	450,00	605,00	1300	1700
	32230	32230U	270	73	60,00	77,00	3,0	2,5	18,200	700,00	1070,00	1300	1700
160	32932	32932XU	220	38	30,00	38,00	2,0	2,0	4,150	276,00	520,00	1500	1900
	32032	32032XU	240	51	38,00	51,00	2,5	2,0	7,800	435,00	790,00	1400	1800
	30232	30232U	290	48	40,00	52,00	3,0	2,5	12,900	525,00	720,00	1200	1600
	32232	32232U	290	80	67,00	84,00	3,0	2,5	23,500	890,00	1420,00	1200	1600
170	32934	32934XU	230	38	30,00	38,00	2,0	2,0	4,400	286,00	560,00	1400	1800
	32034	32034XU	260	57	43,00	57,00	2,5	2,0	10,500	500,00	895,00	1300	1700
	30234	30234U	310	52	43,00	57,00	4,0	3,0	17,000	610,00	845,00	1100	1500
	32234	32234U	310	86	71,00	91,00	4,0	3,0	28,700	1000,00	1600,00	1100	1500
180	32936	32936XU	250	45	34,00	45,00	2,0	2,0	6,540	350,00	700,00	1300	1700
	30236	30236U	320	52	43,00	57,00	4,0	3,0	17,700	630,00	890,00	1100	1400
	32236	32236U	320	86	71,00	91,00	4,0	3,0	30,700	1030,00	1690,00	1100	1400
190	32938	32938XU	260	45	34,00	45,00	2,0	2,0	6,770	355,00	710,00	1200	1600
	32038	32038XUE1	290	64	48,00	64,00	2,5	2,0	15,100	655,00	1210,00	1100	1500
	30238	30238U	340	55	46,00	60,00	4,0	3,0	20,800	715,00	1000,00	1000	1300
	32238	32238U	340	92	75,00	97,00	4,0	3,0	36,100	1150,00	1850,00	1000	1300
200	32940	32940XUE1	280	51	39,00	51,00	2,5	2,0	8,880	485,00	895,00	1100	1500
	32040	32040XUE1	310	70	53,00	70,00	2,5	2,0	19,300	800,00	1470,00	1100	1400
220	32044	4T-32044X	340	76	57,00	76,00	3,0	2,5	25,000	920,00	1690,00	960	1300
240	32048	4T-32048X	360	76	57,00	76,00	3,0	2,5	26,800	930,00	1760,00	870	1200
260	32052	32052XU	400	87	65,00	87,00	4,0	3,0	39,400	1200,00	2270,00	800	1100
360	32972	32972XUE1	480	76	57,00	76,00	3,0	2,5	36,600	1050,00	2330,00	590	780

Zöllige Abmessungen

Die technischen Daten zu jeder Bezeichnung befinden sich auf der in Spalte 3 ausgewiesenen Seite.

0			1			2			3		
Bezeichnung	d (mm)	S.	Bezeichnung	d (mm)	S.	Bezeichnung	d (mm)	S.	Bezeichnung	d (mm)	S.
02473/02420	25,400	17	11162/11300	41,275	20	21075/21212	19,050	16	31593/31520	34,925	18
02474/02420	28,575	17	11590/11520	15,875	16	23100/23256	25,400	17	31594/31520	34,925	18
02872/02820	28,575	17	12580/12520	20,638	16	24780/24720	41,275	20	31597/31520	36,512	19
03062/03162	15,875	16	1280/1220	22,225	16	24780/24721	41,275	20	3188/3120	31,750	18
05062/05185	15,875	16	13685/13621	38,100	19	25577/25520	42,875	20	3188S/3120	31,750	18
05079/05185	20,000	16	13687/13621	38,100	19	25577/25521	42,875	20	33275/33462	69,850	25
05079/05185S	20,000	16	1380/1328	22,225	16	25577/25523	42,875	20	33281/33462	71,438	25
07079/07196	20,000	16	13889/13830	38,100	19	2558/2523S	30,162	18	33281/33472	71,438	25
07087/07196	22,225	16	14116/14276	30,226	18	25580/25520	44,450	21	33287/33462	73,025	26
07087/07210X	22,225	16	14118/14283	30,000	17	25580/25521	44,450	21	3379/3320	34,925	18
07087X/07210X	22,225	16	14124/14276	31,750	18	25580/25522	44,450	21	3386/3320	39,688	20
07098/07204	24,981	16	14125A/14276	31,750	18	25581/25520	44,450	21	33885/33822	44,450	21
07100/07204	25,400	17	14130/14276	33,338	18	25584/25520	44,983	21	33889/33822	50,800	22
07100/07210X	25,400	17	14131/14276	33,338	18	25584/25521	44,980	21	33891/33821	52,388	23
07100S/07196	25,400	17	14137A/14276	34,925	18	25590/25520	45,618	21	33895/33822	53,975	23
07100S/07204	25,400	17	14138A/14274	34,925	18	25590/25521	45,618	21	34300/34478	76,200	26
07100S/07210X	25,400	17	14138A/14276	34,925	18	25590/25522	45,618	21	34301/34478	76,200	26
07100SA/07210X	25,400	17	15100/15245	25,400	17	25590/25523	45,618	21	34306/34478	77,788	26
08125/08231	31,750	18	15100S/15245	25,400	17	2580/2520	31,750	18	34306/34500	77,788	26
09067/09195	19,050	16	15100S/15250X	25,400	17	2580/2523	31,750	18	344/332	40,000	20
09074/09194	19,050	16	15106/15250	26,988	17	25877/25820	34,925	18	3478/3420	34,925	18
09074/09195	19,050	16	15112/15250	28,575	17	25877/25821	34,925	18	3490/3420	38,100	19
09074/09196	19,050	16	15113/15245	28,575	17	25880/25820	36,487	19	355X/352	44,450	21
09081/09196	20,625	16	15117/15244	29,987	17	25880/25821	36,487	19	355X/354X	44,450	21
			15117/15245	29,987	17	2687/2631	25,400	17	3579/3525	42,862	20
			15123/15245	31,750	18	26878/26822	38,100	19	3585/3525	41,275	20
			15123/15250X	31,750	18	26882/26820	41,275	20	3586/3525	45,237	21
			15125/15245	31,750	18	26882/26822	41,275	20	359S/354X	46,038	22
			15578/15520	25,400	17	2689/2631	28,575	17	365/362	50,000	22
			15578/15523	25,400	17	27687/27620	82,550	26	36690/36620	146,050	29
			15580/15520	26,988	17	27690/27620	83,345	27	368A/362A	50,800	22
			15590/15520	28,575	17	27695/27620	84,976	27	36990/36920	177,800	30
			15590/15523	28,575	17	2780/2720	36,487	19	369S/362A	47,625	22
			16150/16282	38,100	19	2788/2720	38,100	19	37425/37625	107,950	28
			16150/16283	38,100	19	2788/2729	38,100	19	37431/37625	109,538	28
			16150/16284	38,100	19	2788/2735X	38,100	19	37431A/37625	109,538	28
			17098/17244	24,981	16	2789/2720	39,688	20	3779/3720	47,625	22
			17118/17244	29,987	17	2789/2729	39,688	20	3780/3720	50,800	22
			17119/17244	30,162	18	2790/2720	33,338	18	3782/3720	44,450	21
			1755/1729	22,225	16	2793/2720	34,925	18	386A/382A	47,625	22
			17580/17520	15,875	16	28137/28317	34,925	18	387/382	57,150	23
			1779/1729	23,812	16	28150/28300	38,100	19	387/382A	57,150	23
			1780/1729	25,400	17	28580/28521	50,800	22	3872/3820	34,925	18
			17887/17831	45,230	21	28584/28521	52,388	23	3876/3820	38,100	19
			18590/18520	41,275	20	28680/28622	55,562	23	3877/3820	41,275	20
			18685/18620	44,450	21	28682/28622	57,150	23	387A/382	57,150	23
			18690/18620	46,038	22	2878/2820	34,925	18	387A/382A	57,150	23
			18790/18720	50,800	22	28985/28920	60,325	24	387A/383A	57,150	23
			19150/19268	38,100	19	28985/28921	60,325	24	390/394A	57,150	23
			19150/19268X	38,100	19	28995/28921	62,738	24	390A/394A	63,500	24
			19150/19283X	38,100	19	29585/29520	63,500	24	39250/39412	63,500	24
			1985/1922	28,575	17	29585/29521	63,500	24	395/394A	63,500	24
			1986/1922	25,400	17	29586/29520	63,500	24	39580/39520	57,150	23
			1988/1922	28,575	17	29590/29520	66,675	25	39581/39520	57,150	23
						29590/29521	66,675	25	39585/39520	63,500	24
						29590/29522	66,675	25	39590/39520	66,675	25
						29675/29620	69,850	25	395A/394	66,675	25
						29685/29620	73,025	26	395A/394A	66,675	25
						29688/29620	73,817	26	395S/394A	66,675	25
						2984/2924	46,038	22	3980/3920	60,325	24
									3982/3920	63,500	24
									3984/3920	66,675	25
									3994/3920	66,675	25
									399A/394A	68,262	25
									399AS/394A	68,262	25

4			5			6			7/8/9		
Bezeichnung	d (mm)	S.	Bezeichnung	d (mm)	S.	Bezeichnung	d (mm)	S.	Bezeichnung	d (mm)	S.
41125/41286	28,575	17	52387/52618	98,425	28	615/612	44,450	21	71450/71750	114,300	29
418/414	38,100	19	52393/52618	100,012	28	623/612	57,150	23	72200C/72487	50,800	22
42350/42584	88,900	27	52400/52618	101,600	28	6280/6220	53,975	23	72212C/72487	53,975	23
42375/42584	95,250	27	52401/52618	101,600	28	6379/6320	65,088	24	745A/742	69,850	25
42381/42584	96,838	27	526/522	41,275	20	6386/6320	66,675	25	748S/742	76,200	26
42687/42620	76,200	26	528/522	47,625	22	639/632	63,500	24	749/742	85,026	27
42690/42620	77,788	26	529/522	50,800	22	641/632	66,675	25	749A/742	82,550	26
43125/43312	31,750	18	529X/522	50,800	22	643/632	69,850	25	759/752	88,900	27
4370/4320	44,450	21	53178/53375	44,450	21	64432/64708	109,974	28	780/772	101,600	28
44150/44348	38,100	19	535/532A	44,450	21	64450/64700	114,300	29	782/772	104,775	28
44162/44348	41,275	20	537/532X	50,800	22	645/632	71,438	25	78214/78551	53,975	23
45284/45220	50,800	22	539/532X	53,975	23	6460/6420	73,025	26	78214C/78551	53,975	23
45285/45220	50,800	22	5395/5335	49,212	22	65200/65500	50,800	22	78225/78551	57,150	23
45289/45220	57,150	23	55175C/55437	44,450	21	65212/65500	53,975	23	78238/78537	60,325	24
45291/45220	57,150	23	55176/55437	44,450	21	65237/65500	60,325	24	78250/78551	63,500	24
4580/4535	50,800	22	55187C/55443	47,625	22	65390/65320	49,212	22	835/832	69,850	25
462/453X	57,150	23	55200C/55437	50,800	22	655/653	69,850	25	842/832	82,550	26
462A/453X	57,150	23	5584/5535	63,500	24	6580/6535	88,900	27	850/832	88,900	27
469/453X	57,150	23	559/552A	63,500	24	6580/6535V1	88,900	27	898/892	139,700	29
47487/47420	69,850	25	56418/56650	106,362	28	6581X/6525X	90,000	27	90381/90744	96,838	27
47490/47420	71,438	25	56425/56650	107,950	28	66200/66462	50,800	22	9278/9220	68,262	25
47679/47620	76,200	26	56426/56650	107,950	28	66225/66462	57,150	23	9285/9220ST	76,200	26
47686/47620	82,550	26	567A/563	71,438	25	663/653	82,550	26	936/932	107,950	28
47890/47820	92,075	27	575/572	76,200	26	665/653	85,725	27	9378/9321	76,200	26
47896/47820	95,250	27	575/572X	76,200	26	66584/66520	53,975	23	938/932	114,300	29
48190/48120	107,950	28	580/572	82,550	26	67388/67322	127,000	29	95500/95925	127,000	29
482/472	69,850	25	581/572	80,962	26	67390/67322	133,350	29	95525/95925	133,350	29
48286/48220	123,825	29	594/592A	95,250	27	67787/67720	174,625	30	98350/98788	88,900	27
48290/48220	127,000	29	594/593X	95,250	27	67790/67720	177,800	30	98400/98788	101,600	28
48385/48320	133,350	29	594A/592A	95,250	27	683/672	95,250	27	99600/99100	152,400	29
48393/48320	136,525	29	598A/592A	92,075	27	68462/68712	117,475	29			
48685/48620	142,875	29				687/672	101,600	28			
495/492A	82,550	26									
497/492A	85,725	27									
497/493	85,725	27									

Zöllige Abmessungen

Die technischen Daten zu jeder Bezeichnung befinden sich auf der in Spalte 3 ausgewiesenen Seite.

A			H			HM			J		
Bezeichnung	d (mm)	S.	Bezeichnung	d (mm)	S.	Bezeichnung	d (mm)	S.	Bezeichnung	d (mm)	S.
A2047/A2126	11,986	16	H212749/H212710	65,987	24	HM204049/HM204010	45,980	22	JH211749/JH211710PK	65,000	24
A4050/A4138	12,700	16	H414242/H414210	66,675	25	HM212047/HM212011	63,500	24	JH307749/JH307710	55,000	23
A4059/A4138	14,989	16	H414245/H414210	68,262	25	HM212049/HM212010	66,675	25	JH415647/JH415610	75,000	26
A6075/A6157	19,050	16	H414249/H414210	71,438	25	HM212049/HM212011	66,675	25	JH415647/JH415610PK	75,000	26
			H715334/H715311	61,912	24	HM215249/HM215210	75,987	26	JHM318448/JHM318410	90,000	27
			H715341A/H715311	66,675	25	HM218238/HM218210	79,974	26	JHM522649/JHM522610	110,000	28
			H715343/H715311	68,262	25	HM218248/HM218210	89,974	27	JHM534149/JHM534110PK	170,000	30
			H715345/H715311	71,438	25	HM220149/HM220110	99,974	28	JHM720249/JHM720210	100,000	28
			H715347/H715311	69,987	25	HM515745/HM515716	76,200	26	JHM807045/JHM807012	50,000	22
			H715348/H715311	77,788	26	HM518445/HM518410	88,900	27	JHM88540/JHM88513PX1	30,000	17
			H913840/H913810	59,987	23	HM801346/HM801310	38,100	19	JL68145/JL68111Z	35,000	19
			H913842/H913810	61,912	24	HM801346X/HM801310	38,100	19	JL69345/JL69310	38,000	19
			H913849/H913810	69,850	25	HM801349/HM801310	40,483	20	JL69349/JL69310	38,000	19
			H917840/H917810	76,200	26	HM803145/HM803110	41,275	20	JL69349/JL69310PK	38,000	19
			H924045/H924010	111,125	28	HM803146/HM803110	41,275	20	JL819349/JL819310	95,000	27
			H924045/H924010D	111,125	28	HM803149/HM803110	44,450	21	JLM104948/JLM104910	50,000	22
			HH221449/HH221410	101,600	28	HM803149/HM803111	44,450	21	JLM104948/JLM104910PK	50,000	22
			HH224335/HH224310	101,600	28	HM803149/HM803112	44,450	21	JLM506849/JLM506810	55,000	23
			HH224349/HH224310V2	114,976	29	HM804840/HM804810	41,275	20	JLM506849/JLM506810PK	55,000	23
			HH228340/HH228310	120,650	29	HM804842/HM804810	44,450	21	JLM508748/JLM508710	60,000	23
			HH228340/HH228310V1	120,650	29	HM804843/HM804810PX1	44,450	21	JLM704649/JLM704610PK	50,000	22
			HH228340/HH228310V3	120,650	29	HM804846/HM804810	47,625	22	JLM710949/JLM710910	65,000	24
			HH228340/HH228318V4	120,650	29	HM804848/HM804810	48,412	22	JLM710949/JLM710910PK	65,000	24
			HH228349/HH228310	127,000	29	HM807040/HM807010	44,450	21	JLM714149/JLM714110PK	75,000	26
			HH923649/HH923610	101,600	28	HM807044/HM807010	49,212	22	JLM813049/JLM813010PK	70,000	25
						HM807046/HM807010	50,800	22			
						HM807048/HM807010	54,488	23			
						HM807049/HM807010	53,975	23			
						HM813840/HM813810	55,562	23			
						HM813849/HM813810	71,438	25			
						HM88542/HM88510	31,750	18			
						HM88547/HM88510	33,338	18			
						HM88648/HM88610PX1	35,717	19			
						HM88649/HM88610	34,925	18			
						HM89249/HM89210	36,512	19			
						HM89443/HM89410	33,338	18			
						HM89446/HM89410	34,925	18			
						HM89448/HM89410	36,512	19			
						HM89449/HM89410	36,512	19			
						HM89449/HM89411	36,512	19			
						HM903245/HM903210	41,275	20			
						HM903245/HM903210PX1	41,275	20			
						HM903248/HM903210	44,988	21			
						HM903249/HM903210	44,450	21			
						HM905843/HM905810	44,988	21			
						HM907643/HM907614	50,800	22			
						HM911245/HM911210	60,325	24			
						HM926740/HM926710	114,300	29			
						HM926745/HM926710	125,298	29			

JM			L			LM			M		
Bezeichnung	d (mm)	S.	Bezeichnung	d (mm)	S.	Bezeichnung	d (mm)	S.	Bezeichnung	d (mm)	S.
JM205149/JM205110	50,000	22	L116149/L116110PX2	82,550	26	LM102949/LM102910	45,242	21	M12648/M12610	22,225	16
JM205149/JM205110PK	50,000	22	L21549/L21511	15,875	16	LM104949/LM104911	50,800	22	M12649/M12610	21,430	16
JM207049/JM207010	55,000	23	L217849/L217810	88,900	27	LM104949/LM104912	50,800	22	M231649/M231610	152,400	29
JM511946/JM511910	65,000	24	L225849/L225810	127,000	29	LM11749/LM11710	17,462	16	M236849/M236810	177,800	30
JM511946/JM511910PK	65,000	24	L319249/L319210	95,250	27	LM11949/LM11910	19,050	16	M238849/M238810	187,325	30
JM515649/JM515610PK	80,000	26	L327249/L327210	133,350	29	LM11949/LM11910V1	19,050	16	M802048/M802011	41,275	20
JM612949/JM612910PK	70,000	25	L420449/L420410	101,600	28	LM11949L/LM11910	19,050	16	M804049/M804010	47,625	22
JM714249/JM714210PK	75,000	26	L432349/L432310	158,750	29	LM12749/LM12711	21,986	16	M84249/M84210	25,400	17
JM716648/JM716610PK	85,000	27	L433749/L433710	158,750	29	LM29748/LM29710	38,100	19	M84548/M84510	25,400	17
JM716649/JM716610	85,000	27	L44643/L44610	25,400	17	LM29748L/LM29710	38,100	19	M84549/M84510	26,988	17
JM716649/JM716610PK	85,000	27	L44643L/L44610	25,400	17	LM29749/LM29710	38,100	19	M86643/M86610	25,400	17
JM718149/JM718110PK	90,000	27	L44649/L44610	26,988	17	LM29749/LM29711	38,100	19	M86647/M86610	28,575	17
JM719149/JM719113	95,000	27	L45449/L45410	29,000	17	LM300849/LM300811	41,000	20	M86649/M86610	30,162	18
JM720249/JM720210	100,000	28	L610549/L610510	63,500	24	LM48548/LM48510	34,925	18	M88040/M88010	28,575	17
JM734449/JM734410	170,000	30	L624549/L624510	120,650	29	LM48548L/LM48510	34,925	18	M88043/M88010	30,162	18
JM736149/JM736110	180,000	30	L68149/L68110	34,988	19	LM501349/LM501310	41,275	20	M88046/M88010	31,750	18
JM738249/JM738210	190,000	30	L68149L/L68111	34,988	19	LM501349/LM501311	41,275	20	M88048/M88010	33,338	18
JM738249/JM738210PK	190,000	30	L713049/L713010	69,850	25	LM501349L/LM501314	41,275	20			
JM822049/JM822010	110,000	28	L814749/L814710	76,200	26	LM503349/LM503310	46,000	22			
JM822049/JM822010PK	110,000	28	LL225749/LL225710	127,000	29	LM503349A/LM503310	45,987	22			
			LL319349/LL319310	95,250	27	LM522548/LM522510	109,987	28			
			LL639249/LL639210	196,850	30	LM522549/LM522510	109,987	28			
						LM603049/LM603011	45,242	21			
						LM603049L/LM603012	45,242	21			
						LM603049L/LM603014	45,242	21			
						LM67048/LM67010	31,750	18			
						LM67048L/LM67010	31,750	18			
						LM67049A/LM67010	31,750	18			
						LM72849/LM72810PX1	22,606	16			
						LM78349/LM78310APX2	34,988	19			
						LM806649/LM806610	53,975	23			
						LM814849/LM814810	77,788	26			

Zöllige Abmessungen

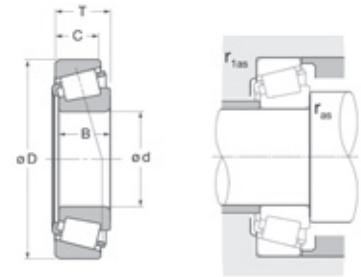

Innendurchmesser (d) mm	NTN-Bezeichnung	Außendurchmesser (D)	Innenringbreite (B)	Außenringbreite (C)	Gesamtbreite (T)	Max. Radius an der Welle (r_{as} max)	Max. Radius am Gehäuse (r_{1as} max)	Gewicht kg	Dynamische Tragzahl C	Statische Tragzahl C0	Grenzdrehzahl mit Fett U/min	Grenzdrehzahl mit Öl U/min
11,986	4T-A2047/A2126	31,991	10,785	7,938	10,008	0,8	1,3	0,050	10,80	9,45	13000	18000
12,700	4T-A4050/A4138	34,988	10,988	8,730	10,998	1,3	1,3	0,053	12,30	11,60	12000	16000
14,989	4T-A4059/A4138	34,989	10,988	8,730	10,998	0,8	1,3	0,050	12,30	11,60	12000	16000
15,875	4T-L21549/L21511	34,989	10,9	8,712	10,998	1,3	1,3	0,050	14,00	13,70	11000	15000
	4T-03062/03162	41,275	14,681	11,112	14,288	1,3	2,0	0,092	20,30	18,70	10000	13000
	4T-11590/11520	42,862	14,288	9,525	14,288	1,5	1,5	0,103	17,60	17,50	8700	12000
	4T-17580/17520	42,862	16,670	13,495	16,670	1,5	1,5	0,122	26,70	26,00	9800	13000
	4T-05062/05185	47,000	14,381	11,112	14,381	1,5	1,3	0,131	24,00	24,20	8600	11000
17,462	4T-LM11749/LM11710	39,878	14,605	10,668	13,843	1,3	1,3	0,084	23,80	24,20	10000	13000
19,050	4T-A6075/A6157	39,992	11,153	9,525	12,014	1,0	1,3	0,065	12,80	12,80	10000	13000
	4T-LM11949L/LM11910	45,237	16,637	12,065	15,494	1,3	1,3	0,128	28,30	28,60	8900	12000
	4T-LM11949/LM11910V1	45,237	16,637	12,065	15,494	1,3	1,3	0,122	28,30	28,60	8900	12000
	4T-LM11949/LM11910	45,237	16,637	12,065	15,494	1,3	1,3	0,122	28,30	28,60	8900	12000
	4T-09067/09195	49,225	19,050	14,288	18,034	1,3	1,3	0,179	38,50	39,00	8500	11000
	4T-09074/09195	49,225	21,539	14,288	19,845	1,5	1,3	0,188	38,50	39,00	8500	11000
	4T-09074/09194	49,225	21,539	17,462	21,209	SPC*	3,5	0,200	38,50	39,00	8500	11000
	4T-09074/09196	49,225	21,539	17,462	23,020	SPC*	1,5	0,200	38,50	39,00	8500	11000
4T-21075/21212	53,975	21,839	15,875	22,225	1,5	2,3	0,248	40,00	39,00	8000	11000	
20,000	4T-05079/05185	47,000	14,381	11,112	14,381	1,5	1,3	0,117	24,00	24,20	8600	11000
	4T-05079/05185S	47,000	14,381	11,112	14,381	1,5	1,3	0,117	24,00	24,20	8600	11000
	4T-07079/07196	50,005	14,260	9,525	13,495	1,5	1,0	0,130	26,00	28,00	7500	10000
20,625	4T-09081/09196	49,225	21,539	17,462	23,020	1,5	1,5	0,190	38,50	39,00	8500	11000
20,638	4T-12580/12520	49,225	19,845	15,875	19,845	1,5	1,5	0,182	37,50	39,00	8200	11000
21,430	4T-M12649/M12610	50,005	18,288	13,970	17,526	1,3	1,3	0,169	38,00	39,00	8000	11000
21,986	4T-LM12749/LM12711	45,974	16,637	12,065	15,494	1,3	1,3	0,123	29,60	34,00	8400	11000
22,225	4T-07087/07196	50,005	14,260	9,525	13,495	1,3	1,0	0,130	26,00	27,90	7500	10000
	4T-M12648/M12610	50,005	18,288	13,970	17,526	1,3	1,3	0,165	38,00	39,00	8000	11000
	4T-07087/07210X	50,800	14,260	12,700	15,011	1,3	1,5	0,140	26,00	28,00	7500	10000
	4T-07087X/07210X	50,800	14,260	12,700	15,011	1,5	1,5	0,140	26,00	28,00	7500	10000
	4T-1380/1328	52,388	20,168	14,288	19,368	1,5	1,5	0,200	40,50	43,00	7600	10000
	4T-1755/1729	56,896	19,837	15,875	19,368	1,3	1,3	0,256	42,50	46,50	7200	9600
	4T-1280/1220	57,150	22,225	17,462	22,225	0,8	1,5	0,286	47,00	49,50	7100	9500
22,606	4T-LM72849/LM72810PX1	47,000	15,500	12,000	15,500	1,5	1,0	0,850	27,50	32,50	8200	11000
23,812	4T-1779/1729	56,896	19,837	15,875	19,368	0,8	1,3	0,247	42,50	46,50	7200	9600
24,981	4T-07098/07 04	51,994	14,260	12,700	15,011	1,5	1,3	0,140	26,00	28,00	7500	10000
	4T-17098/17244	62,000	16,566	14,288	16,002	1,5	1,5	0,256	39,00	42,00	6300	8400

*Spezielle Radien auf Anfrage.

Hinweis:

In unserem Online-Katalog finden Sie alle technischen Daten zu den Wälzlagern.

Zöllige Abmessungen

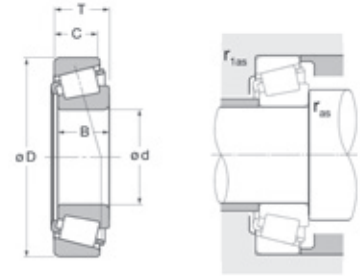

Innendurchmesser	NTN-Bezeichnung	Außendurchmesser	Innenringbreite	Außenringbreite	Gesamtbreite	Max. Radius an der Welle	Max. Radius am Gehäuse	Gewicht	Dynamische Tragzahl C	Statische Tragzahl C0	Grenzdrehzahl mit Fett	Grenzdrehzahl mit Öl
(d)		(D)	(B)	(C)	(T)	(r_{as} max)	(r_{1as} max)					
mm		mm						kg	kN		U/min	
25,400	4T-07100S/07196	50,005	14,260	9,525	13,495	1,5	1,0	0,116	26,00	27,90	7500	10000
	4T-L44643L/L44610	50,292	14,732	10,668	14,224	1,3	1,3	0,130	28,80	34,00	7400	9900
	4T-L44643/L44610	50,292	14,732	10,668	14,224	1,3	1,3	0,130	28,80	34,00	7400	9900
	4T-07100/07210X	50,800	14,260	12,700	15,011	1,0	1,5	0,130	26,00	28,00	7500	10000
	4T-07100S/07210X	50,800	14,260	12,700	15,011	1,5	1,5	0,130	26,00	28,00	7500	10000
	4T-07100SA/07210X	50,800	14,260	12,700	15,011	3,3	1,5	0,130	26,00	28,00	7500	10000
	4T-07100/07204	51,994	14,260	12,700	15,011	1,0	1,3	0,144	26,00	27,90	7500	10000
	4T-07100S/07204	51,994	14,260	12,700	15,011	1,0	1,3	0,144	26,00	27,90	7500	10000
	4T-1780/1729	56,896	19,837	15,875	19,368	0,8	1,3	0,238	42,50	46,50	7200	9600
	4T-15578/15520	57,150	17,462	13,495	17,462	1,3	1,5	0,220	39,50	45,50	6700	8900
	4T-1986/1922	57,150	19,355	15,875	19,845	1,3	1,5	0,250	40,50	44,50	6700	8900
	4T-M84548/M84510	57,150	19,431	14,732	19,431	1,5	1,5	0,241	42,00	48,50	6900	9200
	4T-M84249/M84210	59,530	23,114	18,288	23,368	0,8	1,5	0,330	50,00	57,50	6800	9100
	4T-15578/15523	60,325	17,462	15,875	19,842	1,3	1,5	0,271	39,50	45,50	6700	8900
	4T-15100/15245	62,000	20,638	14,288	19,050	3,5	1,3	0,299	46,50	54,00	6100	8200
	4T-15100S/15245	62,000	20,638	14,288	19,050	1,3	1,3	0,299	46,50	54,00	6100	8200
	4T-15100S/15250X	63,500	20,638	15,875	20,637	1,3	1,5	0,320	46,50	54,00	6100	8200
	4T-M86643/M86610	64,292	21,433	16,670	21,433	1,5	1,5	0,371	51,50	64,50	6100	8100
	4T-23100/23256	65,088	21,463	15,875	22,225	1,5	1,5	0,360	47,00	50,50	5700	7600
	4T-2687/2631	66,421	25,433	19,050	23,812	1,3	1,3	0,442	64,50	72,50	6200	8200
4T-02473/02420	68,262	22,225	17,462	22,225	0,8	1,5	0,430	57,00	67,00	5800	7700	
26,988	4T-L44649/L44610	50,292	14,732	10,668	14,224	3,5	1,3	0,120	28,80	34,00	7400	9900
	4T-15580/15520	57,150	17,462	13,495	17,462	3,5	1,5	0,200	39,50	45,50	6700	8900
	4T-M84549/M84510	57,150	19,431	14,732	19,431	1,5	1,5	0,230	42,00	48,50	6900	9200
	4T-15106/15250	63,500	20,638	15,875	20,637	0,8	1,3	0,310	46,50	54,00	6100	8200
28,575	4T-15590/15520	57,150	17,462	13,495	17,462	3,5	1,5	0,196	39,50	45,50	6700	8900
	4T-1985/1922	57,150	19,355	15,875	19,845	0,8	1,5	0,230	40,50	44,50	6700	8900
	4T-1988/1922	57,150	19,355	15,875	19,845	3,5	1,5	0,220	40,50	44,50	6700	8900
	4T-15590/15523	60,325	17,462	15,875	19,842	3,5	1,5	0,250	39,50	45,50	6700	8900
	4T-15113/15245	62,000	20,638	14,288	19,050	0,8	1,3	0,280	46,50	54,00	6100	8200
	4T-15112/15250	63,500	20,638	15,875	20,637	3,5	1,3	0,300	46,50	54,00	6100	8200
	4T-M86647/M86610	64,292	21,433	16,670	21,433	1,5	1,5	0,348	51,50	64,50	6100	8100
	4T-2689/2631	66,421	25,433	19,050	23,812	1,3	1,3	0,416	64,50	72,50	6200	8200
	4T-02474/02420	68,262	22,225	17,462	22,225	0,8	1,5	0,409	57,00	67,00	5800	7700
	4T-M88040/M88010	68,262	22,225	17,462	22,225	2,3	1,5	0,410	57,50	73,50	6100	8100
29,000	4T-41125/41286	72,626	24,257	17,462	24,608	4,8	1,5	0,477	58,00	55,50	5800	7700
	4T-02872/02820	73,025	22,225	17,462	22,225	0,8	3,3	0,480	56,50	68,00	5300	7000
	4T-L45449/L45410	50,292	14,732	10,668	14,224	3,5	1,3	0,113	28,00	35,50	7200	9600
	4T-17118/17244	62,000	16,566	14,288	16,002	1,5	1,5	0,228	39,00	42,00	6300	8400
29,987	4T-15117/15245	62,000	20,638	14,288	19,050	1,3	1,3	0,269	46,50	54,00	6100	8200
	4T-15117/15244	62,000	20,638	15,875	20,637	1,3	1,3	0,270	46,50	54,00	6100	8200
30,000	4T-JHM88540/JHM88513PX1	72,000	27,783	23,020	29,370	1,3	3,3	0,610	72,00	97,00	5400	7100
	4T-14118/14283	72,085	19,202	18,415	22,385	0,8	2,3	0,440	48,50	58,00	5600	7400

Zöllige Abmessungen

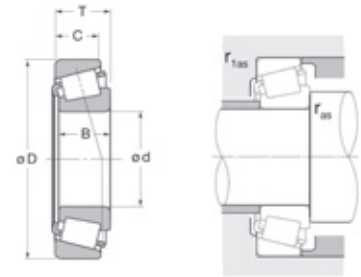

Innendurchmesser (d) mm	NTN-Bezeichnung	Außendurchmesser (D)	Innenringbreite (B)	Außenringbreite (C)	Gesamtbreite (T)	Max. Radius an der Welle (r _{1as} max)	Max. Radius am Gehäuse (r _{2as} max)	Gewicht kg	Dynamische Tragzahl C	Statische Tragzahl C ₀	Grenzdrehzahl mit Fett U/min	Grenzdrehzahl mit Öl U/min
30,162	4T-17119/17244	62,000	16,566	14,288	16,002	1,5	1,5	0,226	39,00	42,00	6300	8400
	4T-M86649/M86610	64,292	21,433	16,670	21,433	1,5	1,5	0,336	51,50	64,50	6100	8100
	4T-M88043/M88010	68,262	22,225	17,462	22,225	2,3	1,5	0,400	57,50	73,50	6100	8100
	4T-2558/2523S	69,850	25,357	19,050	23,812	2,3	1,3	0,468	69,00	81,50	5700	7600
30,226	4T-14116/14276	69,012	19,583	15,875	19,845	0,8	1,3	0,370	48,50	58,00	5600	7400
31,750	4T-08125/08231	58,738	15,080	10,716	14,683	1,0	1,0	0,170	28,20	32,50	6300	8400
	4T-LM67048L/LM67010	59,131	16,764	11,811	15,875	3,9	1,3	0,180	34,50	41,00	6300	8400
	4T-LM67049A/LM67010	59,131	16,764	11,811	15,875	0,8	1,3	0,180	34,50	41,00	6300	8400
	4T-LM67048/LM67010	59,131	16,764	11,811	15,875	3,9	1,3	0,182	34,50	41,00	6300	8400
	4T-15123/15245	62,000	19,050	14,288	18,161	4,7	1,3	0,244	46,50	54,00	6100	8200
	4T-15125/15245	62,000	20,638	14,288	19,050	3,5	1,3	0,253	46,50	54,00	6100	8200
	4T-15123/15250X	63,500	19,050	15,875	20,637	4,7	1,5	0,260	46,50	54,00	6100	8200
	4T-2580/2520	66,421	25,357	20,638	25,400	0,8	3,3	0,409	69,00	81,50	5700	7600
	4T-M88046/M88010	68,262	22,225	17,462	22,225	1,5	1,5	0,390	57,50	73,50	6100	8100
	4T-14124/14276	69,012	19,583	15,875	19,845	0,8	1,3	0,359	48,50	58,00	5600	7400
	4T-14125A/14276	69,012	19,583	15,875	19,845	3,5	1,3	0,356	48,50	58,00	5600	7400
	4T-2580/2523	69,850	25,357	19,050	23,812	0,8	1,3	0,454	69,00	81,50	5700	7600
	4T-3188/3120	72,626	29,997	23,812	30,162	0,8	3,3	0,603	84,50	98,00	5500	7300
	4T-3188S/3120	72,626	29,997	23,812	30,162	1,6	3,3	0,603	84,50	98,00	5500	7300
4T-HM88542/HM88510	73,025	27,783	23,020	29,370	1,3	3,3	0,622	72,00	97,00	5400	7100	
4T-43125/43312	79,375	24,074	17,462	25,400	1,5	1,5	0,580	65,50	67,00	5200	6900	
33,338	4T-M88048/M88010	68,262	22,225	17,462	22,225	0,8	1,5	0,378	56,50	71,00	5700	7500
	4T-14130/14276	69,012	19,583	15,875	19,845	3,5	1,3	0,344	48,50	58,00	5600	7400
	4T-14131/14276	69,012	19,583	15,875	19,845	0,8	1,3	0,347	48,50	58,00	5600	7400
	4T-HM88547/HM88510	73,025	27,783	23,020	29,370	0,8	3,3	0,604	72,00	97,00	5400	7100
	4T-2790/2720	76,200	25,654	19,050	23,812	1,5	3,3	0,553	73,00	90,50	5100	6800
	4T-HM89443/HM89410	76,200	28,575	23,020	29,370	0,8	3,3	0,668	78,00	105,00	5100	6800
34,925	4T-LM48548/LM48510	65,088	18,288	13,970	18,034	3,9	1,3	0,249	46,50	56,00	5700	7600
	4T-LM48548L/LM48510	65,088	18,288	13,970	18,034	3,9	1,3	0,249	46,50	56,00	5700	7600
	4T-14138A/14274	69,012	19,583	15,875	19,845	3,5	3,3	0,320	48,50	58,00	5600	7400
	4T-14137A/14276	69,012	19,583	15,875	19,845	1,5	1,3	0,333	48,50	58,00	5600	7400
	4T-14138A/14276	69,012	19,583	15,875	39,705	3,5	1,3	0,320	48,50	58,00	5600	7400
	4T-HM88649/HM88610	72,233	25,400	19,842	25,400	2,3	2,3	0,489	65,00	84,50	5400	7200
	4T-2878/2820	73,025	23,812	17,462	22,225	0,8	3,3	0,434	62,50	75,50	5200	7000
	4T-25877/25820	73,025	24,608	19,050	23,812	1,5	2,3	0,471	71,00	85,00	5300	7100
	4T-25877/25821	73,025	24,608	19,050	23,812	1,5	0,8	0,474	71,00	85,00	5300	7100
	4T-2793/2720	76,200	25,654	19,050	23,812	0,8	3,3	0,536	73,00	90,50	5100	6800
	4T-HM89446/HM89410	76,200	28,575	23,020	29,370	3,5	3,3	0,646	78,00	105,00	5100	6800
	4T-31593/31520	76,200	28,575	23,812	29,370	3,5	3,3	0,625	80,50	97,00	5100	6800
	4T-31594/31520	76,200	28,575	23,812	29,370	1,5	3,3	0,627	80,50	97,00	5100	6800
	4T-3478/3420	79,375	29,771	23,812	29,370	3,5	3,3	0,725	93,00	114,00	4900	6600
	4T-28137/28317	80,035	20,940	15,875	21,433	1,5	1,5	0,500	55,50	63,00	5000	6700
	4T-3379/3320	80,167	30,391	23,812	29,370	3,5	3,3	0,732	95,00	112,00	4800	6400
4T-3872/3820	85,725	30,162	23,812	30,162	3,5	3,3	0,897	105,00	132,00	4500	6000	

Zöllige Abmessungen

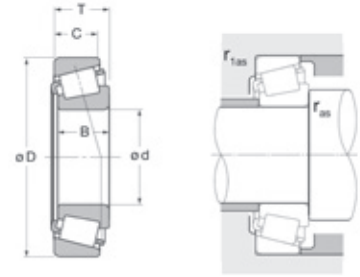

Innendurchmesser (d) mm	NTN-Bezeichnung	Außendurchmesser (D)	Innenringbreite (B)	Außenringbreite (C)	Gesamtbreite (T)	Max. Radius an der Welle (r _{as} max)	Max. Radius am Gehäuse (r _{1as} max)	Gewicht kg	Dynamische Tragzahl C	Statische Tragzahl C ₀	Grenzdrehzahl mit Fett U/min	Grenzdrehzahl mit Öl U/min
34,988	4T-L68149/L68110	59,131	16,764	11,938	15,875	3,9	1,3	0,170	35,50	47,50	6100	8100
	4T-L68149/L68111	59,974	16,764	11,938	15,875	3,9	1,3	0,179	35,50	47,50	6100	8100
	4T-LM78349/LM78310APX2	61,973	17,000	13,600	16,702	3,5	1,5	0,190	37,00	48,00	5900	7900
35,000	4T-JL68145/JL68111Z	60,000	18,461	11,938	15,875	2,0	1,3	0,180	35,50	47,50	6100	8100
35,717	4T-HM88648/HM88610PX1	72,233	25,400	19,842	25,400	3,5	2,0	0,480	65,00	84,50	5400	7200
36,487	4T-25880/25821	73,025	24,608	19,050	23,812	1,5	0,8	0,457	71,00	85,00	5300	7100
	4T-25880/25820	73,025	24,608	19,050	23,813	1,5	2,3	0,447	76,00	98,00	4500	6000
	4T-2780/2720	76,200	25,654	19,050	23,812	1,5	3,3	0,518	73,00	90,50	5100	6800
36,512	4T-HM89448/HM89410	76,200	28,575	23,020	29,370	0,8	3,3	0,629	78,00	105,00	5100	6800
	4T-HM89449/HM89410	76,200	28,575	23,020	29,370	3,5	3,3	0,626	78,00	105,00	5100	6800
	4T-HM89449/HM89411	76,200	28,575	23,020	29,370	3,5	0,8	0,631	78,00	105,00	5100	6800
	4T-31597/31520	76,200	28,575	23,812	29,370	3,5	3,3	0,605	80,50	97,00	5100	6800
	4T-HM89249/HM89210	79,375	28,829	22,664	29,370	3,5	3,3	0,686	86,50	104,00	5000	6600
38,000	4T-JL69349/JL69310	63,000	17,000	13,500	17,000	3,9	1,3	0,198	38,50	52,50	5700	7600
	4T-JL69349/JL69310PK	63,000	17,000	13,500	17,000	3,9	1,5	0,200	38,50	52,50	5700	7600
	4T-JL69345/JL69310	63,000	19,000	13,500	17,000	SPC*	1,3	0,200	38,50	52,50	5700	7600
38,100	4T-13889/13830	63,500	11,908	9,525	12,700	1,5	0,8	0,147	25,90	33,50	5500	7300
	4T-LM29748/LM29710	65,088	18,288	13,970	18,034	3,9	1,3	0,233	43,50	57,00	5500	7400
	4T-LM29748L/LM29710	65,088	18,288	13,970	18,034	3,9	1,3	0,233	43,50	57,00	5500	7400
	4T-LM29749/LM29710	65,088	18,288	13,970	18,034	2,3	1,3	0,235	43,50	57,00	5500	7400
	4T-LM29749/LM29711	65,088	18,288	15,748	19,812	2,3	1,3	0,250	43,50	57,00	5500	7400
	4T-19150/19268	68,262	16,520	11,908	15,875	1,5	1,5	0,240	43,50	51,00	5400	7200
	4T-19150/19268X	68,275	16,520	16,032	20,000	1,5	1,5	0,280	43,50	51,00	5400	7200
	4T-13685/13621	69,012	19,050	15,083	19,050	3,5	2,3	0,293	47,50	59,50	5300	7100
	4T-13687/13621	69,012	19,050	15,083	19,050	2,0	2,3	0,296	47,50	59,50	5300	7100
	4T-19150/19283X	72,000	16,520	14,288	17,018	1,5	1,5	0,300	43,50	51,00	5400	7200
	4T-16150/16282	72,000	20,638	14,237	19,000	3,5	1,5	0,331	48,00	58,50	5300	7000
	4T-16150/16284	72,238	20,638	15,875	20,638	3,5	1,3	0,355	48,00	58,50	5300	7000
	4T-16150/16283	72,238	20,638	19,050	23,813	3,5	2,3	0,390	48,00	58,50	5300	7000
	4T-2788/2735X	73,025	25,654	19,050	23,775	3,5	0,8	0,440	73,00	90,50	5100	6800
	4T-28150/28300	76,200	20,940	15,507	20,638	1,5	1,3	0,405	55,50	63,00	5000	6700
	4T-2788/2729	76,200	25,654	19,050	23,775	3,5	0,8	0,494	73,00	90,50	5100	6800
	4T-2788/2720	76,200	25,654	19,050	23,812	3,5	3,3	0,497	73,00	90,50	5100	6800
	4T-26878/26822	79,375	25,400	19,050	23,812	0,8	0,8	0,574	76,50	97,50	4800	6400
	4T-3490/3420	79,375	29,771	23,812	29,370	3,5	3,3	0,683	93,00	114,00	4900	6600
	4T-HM801346/HM801310	82,550	28,575	23,020	29,370	0,8	3,3	0,767	87,00	117,00	4700	6200
	4T-HM801346X/HM801310	82,550	28,575	23,020	29,370	2,3	3,3	0,767	87,00	117,00	4700	6200
4T-3876/3820	85,725	30,162	23,812	30,162	3,5	3,3	0,854	105,00	132,00	4500	6000	
4T-44150/44348	88,500	23,698	17,462	25,400	2,3	1,5	0,711	70,50	78,00	4000	5300	
4T-418/414	88,500	29,083	22,225	26,988	3,5	1,5	0,840	95,50	107,00	4600	6100	

*Spezielle Radien auf Anfrage.

Hinweis:
In unserem Online-Katalog finden Sie alle technischen Daten zu den Wälzlagern.

Zöllige Abmessungen

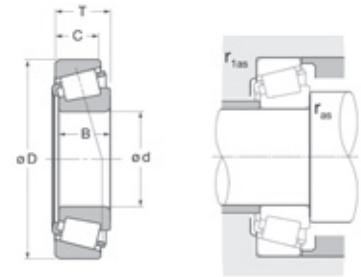

Innendurchmesser (d) mm	NTN-Bezeichnung	Außendurchmesser (D)	Innenringbreite (B)	Außenringbreite (C)	Gesamtbreite (T)	Max. Radius an der Welle (r_{as} max)	Max. Radius am Gehäuse (r_{1as} max)	Gewicht kg	Dynamische Tragzahl C kN	Statische Tragzahl C0	Grenzdrehzahl mit Fett U/min	Grenzdrehzahl mit Öl U/min
39,688	4T-2789/2729	76,200	25,654	19,050	23,775	3,5	0,8	0,480	73,00	90,50	5100	6800
	4T-2789/2720	76,200	25,654	19,050	23,812	3,5	3,3	0,477	73,00	90,50	5100	6800
	4T-3386/3320	80,167	30,391	23,812	29,370	0,8	3,3	0,668	95,00	112,00	4800	6400
40,000	4T-344/332	80,000	22,403	17,826	21,000	3,5	1,3	0,479	68,00	75,00	4700	6300
40,483	4T-HM801349/HM801310	82,550	28,575	23,020	29,370	3,5	3,3	0,731	87,00	117,00	4700	6200
41,000	4T-LM300849/LM300811	67,975	18,000	13,500	17,500	3,9	1,5	0,239	46,00	62,50	5300	7000
41,275	4T-18590/18520	73,025	17,462	12,700	16,667	3,5	1,5	0,281	46,00	55,50	5000	6600
	4T-LM501349/LM501310	73,431	19,812	14,732	19,558	3,5	0,8	0,335	56,00	69,50	5000	6600
	4T-LM501349/LM501314	73,431	19,812	16,604	21,430	3,5	0,8	0,355	56,00	69,50	5000	6600
	4T-LM501349/LM501311	73,431	19,812	18,186	23,012	3,5	2,3	0,370	54,00	66,00	5000	6600
	4T-11162/11300	76,200	17,384	14,288	18,009	1,5	1,5	0,337	42,50	51,50	4900	6500
	4T-24780/24720	76,200	23,020	17,462	22,225	3,5	0,8	0,432	65,00	80,50	4900	6500
	4T-24780/24721	76,200	23,020	20,638	25,400	3,5	2,3	0,470	65,00	80,50	4900	6500
	4T-26882/26822	79,375	25,400	19,050	23,812	3,5	0,8	0,531	76,50	97,50	4800	6400
	4T-26882/26820	80,167	25,400	20,638	25,400	3,5	3,3	0,563	76,50	97,50	4800	6400
	4T-M802048/M802011	82,550	25,654	20,193	26,543	3,5	3,3	0,642	80,50	104,00	4600	6100
	4T-3877/3820	85,725	30,162	23,812	30,163	3,5	3,3	0,830	105,00	132,00	4500	6000
	4T-3585/3525	87,312	30,886	23,812	30,162	1,5	3,3	0,835	94,00	117,00	4400	5900
	4T-44162/44348	88,500	23,698	17,462	25,400	2,3	1,5	0,680	70,50	78,00	4000	5300
	4T-HM803145/HM803110	88,900	29,370	23,020	30,162	0,8	3,3	0,901	93,50	125,00	4300	5800
	4T-HM803146/HM803110	88,900	29,370	23,020	30,162	3,5	3,3	0,898	93,50	125,00	4300	5800
	4T-HM903245/HM903210	95,250	28,575	22,225	30,958	3,5	0,8	1,050	96,00	116,00	3700	4900
	4T-HM903245/HM903210PX1	95,250	28,575	22,225	30,958	3,5	0,8	1,060	96,00	116,00	3700	4900
4T-HM804840/HM804810	95,250	29,370	23,020	30,162	3,5	3,3	1,080	109,00	147,00	4000	5300	
4T-526/522	101,600	36,068	26,988	34,925	3,5	3,3	1,420	135,00	165,00	3800	5000	
42,862	4T-3579/3525	87,312	30,886	23,812	30,162	3,5	3,3	0,805	94,00	117,00	4400	5900
42,875	4T-25577/25520	82,931	25,400	19,050	23,812	3,5	0,8	0,581	76,00	98,00	4500	6000
	4T-25577/25523	82,931	25,400	22,225	26,988	3,5	3,3	0,610	76,00	98,00	4500	6000
	4T-25577/25521	83,058	25,400	19,050	23,813	3,5	3,3	0,560	76,00	98,00	4500	6000

Zöllige Abmessungen

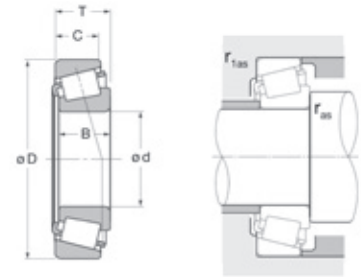

Innendurchmesser	NTN-Bezeichnung	Außendurchmesser	Innenringbreite	Außenringbreite	Gesamtbreite	Max. Radius an der Welle	Max. Radius am Gehäuse	Gewicht	Dynamische Tragzahl C	Statische Tragzahl C0	Grenzdrehzahl mit Fett	Grenzdrehzahl mit Öl
(d)		(D)	(B)	(C)	(T)	(r_{as} max)	(r_{1as} max)					
mm		mm						kg	kN		U/min	
44,450	4T-18685/18620	79,375	17,462	13,495	17,462	2,8	1,5	0,345	45,50	56,00	4600	6200
	4T-25580/25520	82,931	25,400	19,050	23,812	3,5	0,8	0,560	76,00	98,00	4500	6000
	4T-25581/25520	82,931	25,400	19,050	23,812	0,5	0,8	0,563	76,00	98,00	4500	6000
	4T-25580/25521	83,058	25,400	19,050	23,813	3,5	3,3	0,540	76,00	98,00	4500	6000
	4T-25580/25522	83,058	25,400	19,114	23,876	3,5	2,0	0,550	76,00	98,00	4500	6000
	4T-355X/354X	85,000	21,692	17,462	20,638	2,3	1,3	0,511	69,50	79,50	4400	5800
	4T-4370/4320	88,500	40,386	33,338	39,687	3,5	3,3	1,110	136,00	175,00	4300	5800
	4T-HM803149/HM803111	88,900	29,370	23,020	30,162	3,5	0,8	0,850	93,50	125,00	4300	5800
	4T-HM803149/HM803110	88,900	29,370	23,020	30,162	3,5	3,3	0,849	93,50	125,00	4300	5800
	4T-355X/352	90,119	21,692	21,808	23,000	3,5	2,3	0,670	69,50	79,50	4400	5800
	4T-HM803149/HM803112	92,075	29,370	23,020	30,162	3,5	3,3	0,920	93,50	125,00	4300	5800
	4T-3782/3720	93,264	30,302	23,812	30,162	3,5	3,3	0,961	102,00	134,00	4000	5300
	4T-53178/53375	95,250	28,300	20,638	30,958	2,0	0,8	0,927	82,50	92,00	3700	5000
	4T-33885/33822	95,250	28,575	22,225	27,783	0,8	0,8	0,970	107,00	139,00	3900	5200
	4T-HM903249/HM903210	95,250	28,575	22,225	30,958	3,5	0,8	1,000	96,00	116,00	3700	4900
	4T-HM804843/HM804810PX1	95,250	29,370	23,020	30,162	3,5	3,3	1,020	109,00	147,00	4000	5300
	4T-HM804842/HM804810	95,250	29,370	23,020	30,162	0,8	3,3	1,040	109,00	147,00	4000	5300
	4T-HM807040/HM807010	104,775	36,512	28,575	36,512	3,5	3,3	1,620	138,00	189,00	3600	4800
	4T-55175C/55437	111,125	26,909	20,638	30,162	3,5	3,3	1,450	104,00	136,00	3200	4200
	4T-55176/55437	111,125	26,909	20,638	30,162	0,8	3,3	1,090	104,00	136,00	3200	4200
4T-535/532A	111,125	36,957	30,162	38,100	3,5	3,3	1,830	141,00	177,00	3600	4800	
4T-615/612	120,650	41,275	31,750	41,275	3,5	3,3	2,430	172,00	213,00	3300	4400	
44,980	4T-25584/25521	82,830	25,400	19,050	23,810	1,5	3,3	0,560	76,00	98,00	4500	6000
44,983	4T-25584/25520	82,931	25,400	19,050	23,812	1,5	0,8	0,555	76,00	98,00	4500	6000
44,988	4T-HM903248/HM903210	95,250	28,575	22,225	30,958	3,5	0,8	1,000	96,00	116,00	3700	4900
	4T-HM905843/HM905810	104,986	31,750	23,368	32,512	2,5	2,5	1,380	113,00	151,00	3700	4400
45,230	4T-17887/17831	79,985	20,638	15,080	30,559	2,0	1,3	0,400	59,50	75,50	5400	7200
45,237	4T-3586/3525	87,312	30,886	23,812	30,162	3,5	3,3	0,765	94,00	117,00	4400	5900
45,242	4T-LM102949/LM102910	73,431	19,812	15,748	19,558	3,5	0,8	0,307	54,00	76,00	4800	6400
	4T-LM603049/LM603011	77,788	19,842	15,080	19,842	3,5	0,8	0,372	57,50	73,50	4600	6200
	4T-LM603049/LM603012	77,788	19,842	16,667	21,430	3,5	0,8	0,391	57,50	73,50	4600	6200
	4T-LM603049/LM603014	79,974	19,842	15,080	19,842	3,5	0,8	0,405	57,50	73,50	4600	6200
45,618	4T-25590/25520	82,931	25,400	19,050	23,812	3,5	0,8	0,543	76,00	98,00	4500	6000
	4T-25590/25523	82,931	25,400	22,225	26,988	3,5	2,3	0,588	76,00	98,00	4500	6000
	4T-25590/25521	83,058	25,400	19,050	23,812	3,5	3,3	0,541	76,00	98,00	4500	6000
	4T-25590/25522	83,058	25,400	19,114	23,876	3,5	2,0	0,545	76,00	98,00	4500	6000
45,980	4T-HM204049/HM204010	90,975	32,000	26,500	32,000	3,5	3,5	0,920	117,00	147,00	4200	5600
45,987	4T-LM503349A/LM503310	74,976	18,000	14,000	18,000	SPC*	1,5	0,290	51,00	71,00	4700	6300

*Spezielle Radien auf Anfrage.

Hinweis:
In unserem Online-Katalog finden Sie alle technischen Daten zu den Wälzlagern.

Zöllige Abmessungen

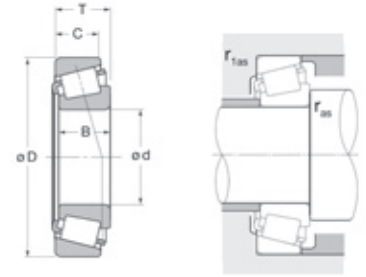

Innendurchmesser (d) mm	NTN-Bezeichnung	Außendurchmesser (D)	Innenringbreite (B)	Außenringbreite (C)	Gesamtbreite (T)	Max. Radius an der Welle (r _{as} max)	Max. Radius am Gehäuse (r _{1as} max)	Gewicht kg	Dynamische Tragzahl C	Statische Tragzahl C ₀	Grenzdrehzahl mit Fett U/min	Grenzdrehzahl mit Öl U/min
46,000	4T-LM503349/LM503310	74,976	18,000	14,000	18,000	3,9	1,5	0,296	51,00	71,00	4700	6300
46,038	4T-18690/18620	79,375	17,462	13,495	17,462	2,8	1,5	0,329	45,50	56,00	4600	6200
	4T-359S/354X	85,000	21,692	17,462	20,638	3,5	1,3	0,489	69,50	79,50	4400	5800
	4T-2984/2924	85,000	25,608	20,638	25,400	3,5	1,3	0,615	79,00	104,00	4400	5800
47,625	4T-369S/362A	88,900	22,225	16,513	20,638	2,3	1,3	0,561	76,50	90,50	4100	5500
	4T-M804049/M804010	88,900	25,400	19,050	25,400	3,5	3,3	0,657	82,00	101,00	4200	5600
	4T-3779/3720	93,264	30,302	23,812	30,162	3,5	3,3	0,904	102,00	134,00	4000	5300
	4T-HM804846/HM804810	95,250	29,370	23,020	30,162	3,5	3,3	0,978	109,00	147,00	4000	5300
	4T-386A/382A	96,838	21,946	15,875	21,000	0,8	0,8	0,720	78,00	96,50	3700	5000
	4T-528/522	101,600	36,068	26,988	34,925	3,5	3,3	1,300	135,00	165,00	3800	5000
	4T-55187C/55443	112,712	26,909	20,638	30,163	3,5	3,3	1,450	91,50	108,00	3200	4200
48,412	4T-HM804848/HM804810	95,250	29,370	23,020	30,162	2,3	3,3	0,967	109,00	147,00	4000	5300
49,212	4T-5395/5335	103,188	44,475	36,512	43,658	3,5	3,3	1,750	174,00	232,00	3800	5000
	4T-HM807044/HM807010	104,775	36,512	28,575	36,512	3,5	3,3	1,520	138,00	189,00	3600	4800
	4T-65390/65320	114,300	44,450	34,925	44,450	3,5	3,3	2,230	186,00	225,00	3600	4800
50,000	4T-JLM104948/JLM104910	82,000	21,500	17,000	21,500	3,0	0,5	0,420	69,50	94,00	4300	5700
	4T-JLM104948/JLM104910PK	82,000	21,500	17,000	21,500	3,0	0,5	0,420	69,50	94,00	4300	5700
	4T-JLM704649/JLM704610PK	84,000	22,000	17,500	22,000	3,5	1,5	0,466	69,50	94,50	4300	5700
	4T-365/362	88,900	22,225	16,513	20,638	2,0	1,3	0,530	76,50	90,50	4100	5500
	4T-JM205149/JM205110	90,000	28,000	23,000	28,000	3,0	2,5	0,752	106,00	141,00	4100	5400
	4T-JM205149/JM205110PK	90,000	28,000	23,000	28,000	3,0	2,5	0,750	106,00	141,00	4100	5400
4T-JHM807045/JHM807012	105,000	36,000	29,000	37,000	3,0	2,5	1,520	138,00	189,00	3600	4800	
50,800	4T-LM104949/LM104911	82,550	22,225	16,510	21,590	3,5	1,3	0,419	69,50	94,00	4300	5700
	4T-LM104949/LM104912	82,930	22,220	16,510	21,590	3,5	1,3	0,420	69,50	94,00	4300	5700
	4T-18790/18720	85,000	17,462	13,495	17,462	3,5	1,5	0,374	49,50	65,00	4200	5600
	4T-368A/362A	88,900	22,225	16,513	20,638	3,5	1,3	0,516	76,50	90,50	4100	5500
	4T-28580/28521	92,075	25,400	19,845	24,608	3,5	0,8	0,703	83,50	116,00	4000	5300
	4T-3780/3720	93,264	30,302	23,812	30,162	3,5	3,3	0,848	102,00	134,00	4000	5300
	4T-33889/33822	95,250	28,575	22,225	28,575	3,5	0,8	0,879	107,00	139,00	3900	5200
	4T-529/522	101,600	36,068	26,988	34,925	0,8	3,3	1,240	135,00	165,00	3800	5000
	4T-529X/522	101,600	36,068	26,988	34,925	3,5	3,3	1,230	135,00	165,00	3800	5000
	4T-45284/45220	104,775	30,958	23,812	30,162	6,4	3,3	1,220	130,00	169,00	3500	4700
	4T-45285/45220	104,775	30,958	23,812	30,162	2,3	3,3	1,230	130,00	169,00	3500	4700
	4T-HM807046/HM807010	104,775	36,512	28,575	36,512	3,5	3,3	1,490	138,00	189,00	3600	4800
	4T-4580/4535	104,775	40,157	33,338	39,687	3,5	3,3	1,620	151,00	212,00	3600	4800
	4T-537/532X	107,950	36,957	28,575	36,512	3,5	3,3	1,550	141,00	177,00	3600	4800
	4T-55200C/55437	111,125	26,909	20,638	30,163	3,5	3,3	1,360	91,50	108,00	3200	4200
	4T-HM907643/HM907614	111,125	28,575	20,638	30,162	3,5	3,3	1,360	104,00	136,00	3200	4200
	4T-66200/66462	117,475	31,750	23,812	33,338	3,5	3,3	1,670	130,00	153,00	3300	4400
4T-72200C/72487	123,825	32,791	25,400	36,512	3,5	3,3	2,100	154,00	188,00	2900	3900	
4T-65200/65500	127,000	44,450	34,925	44,450	3,5	3,3	2,880	203,00	263,00	3100	4200	

Zöllige Abmessungen

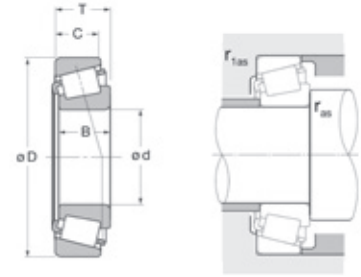

Innendurchmesser (d) mm	NTN-Bezeichnung	Außendurchmesser (D)	Innenringbreite (B)	Außenringbreite (C)	Gesamtbreite (T)	Max. Radius an der Welle (r _{as max})	Max. Radius am Gehäuse (r _{1as max})	Gewicht kg	Dynamische Tragzahl C	Statische Tragzahl C ₀	Grenzdrehzahl mit Fett U/min	Grenzdrehzahl mit Öl U/min
52,388	4T-28584/28521	92,075	25,400	19,845	24,608	3,5	0,8	0,677	83,50	116,00	4000	5300
	4T-33891/33821	95,250	28,575	22,225	27,783	3,5	2,3	0,847	107,00	139,00	3900	5200
53,975	4T-LM806649/LM806610	88,900	19,050	13,492	19,050	2,3	2,0	0,437	61,00	82,50	4000	5300
	4T-33895/33822	95,250	28,575	22,225	27,783	1,5	0,8	0,824	107,00	139,00	3900	5200
	4T-HM807049/HM807010	104,775	36,512	28,575	36,512	3,5	3,3	1,410	138,00	189,00	3600	4800
	4T-539/532X	107,950	36,957	28,575	36,512	3,5	3,3	1,470	141,00	177,00	3600	4800
	4T-66584/66520	122,238	31,750	23,812	33,338	3,5	3,3	1,790	134,00	163,00	3100	4200
	4T-72212C/72487	123,825	32,791	25,400	36,512	3,5	3,3	2,030	154,00	188,00	2900	3900
	4T-65212/65500	127,000	44,450	34,925	44,450	3,5	3,3	2,790	203,00	263,00	3100	4200
	4T-6280/6220	127,000	52,388	41,275	50,800	3,5	3,3	3,250	250,00	320,00	3200	4300
	4T-78214/78551	140,030	33,236	23,520	36,512	0,8	2,3	2,770	171,00	212,00	2600	3400
4T-78214C/78551	140,030	33,236	23,520	36,512	0,8	2,3	2,770	171,00	212,00	2600	3400	
54,488	4T-HM807048/HM807010	104,775	36,512	28,575	36,512	3,5	3,3	1,400	138,00	189,00	3600	4800
55,000	4T-JLM506849/JLM506810	90,000	23,000	18,500	23,000	1,5	0,5	0,558	77,50	109,00	3900	5300
	4T-JLM506849/JLM506810PK	90,000	23,000	18,500	23,000	1,5	0,5	0,558	77,50	109,00	3900	5300
	4T-JM207049/JM207010	95,000	29,000	23,500	29,000	1,5	2,5	0,820	107,00	144,00	3800	5100
	4T-JH307749/JH307710	110,000	39,000	32,000	39,000	3,0	2,5	1,710	173,00	219,00	3500	4600
55,562	4T-28680/28622	97,630	24,608	19,446	24,608	3,5	0,8	0,774	88,50	128,00	3700	4900
	4T-HM813840/HM813810	127,000	36,512	26,988	36,512	3,5	3,3	2,340	163,00	228,00	2900	3800
57,150	4T-387/382	96,838	21,946	15,875	21,000	2,3	0,8	0,583	78,00	96,50	3700	5000
	4T-387/382A	96,838	21,946	15,875	21,000	2,3	0,8	0,583	78,00	96,50	3700	5000
	4T-387A/382A	96,838	21,946	15,875	21,000	3,5	0,8	0,581	78,00	96,50	3700	5000
	4T-28682/28622	97,630	24,608	19,446	24,608	3,5	0,8	0,747	88,50	128,00	3700	4900
	4T-387A/382	98,425	21,946	17,826	21,000	3,5	0,8	0,628	78,00	96,50	3700	5000
	4T-387A/383A	100,000	21,946	17,826	21,000	3,5	2,0	0,660	78,00	96,50	3700	5000
	4T-462/453X	104,775	29,317	24,605	30,162	2,3	3,3	1,060	115,00	148,00	3500	4700
	4T-462A/453X	104,775	29,317	24,605	30,162	2,3	3,3	1,060	115,00	148,00	3500	4700
	4T-469/453X	104,775	29,317	24,605	30,162	3,5	3,3	1,060	115,00	148,00	3500	4700
	4T-45289/45220	104,775	30,958	23,812	30,162	0,8	3,3	1,100	130,00	169,00	3500	4700
	4T-45291/45220	104,775	30,958	23,812	30,162	6,4	3,3	1,090	130,00	169,00	3500	4700
	4T-390/394A	110,000	21,996	18,824	22,000	2,3	1,3	0,954	89,50	120,00	3200	4300
	4T-39580/39520	112,712	30,162	23,812	30,162	3,5	3,3	1,410	138,00	195,00	3200	4200
	4T-39581/39520	112,712	30,162	23,812	30,162	8,0	3,3	1,400	138,00	195,00	3200	4200
	4T-66225/66462	117,475	31,750	23,812	33,338	3,5	3,3	1,540	130,00	153,00	3300	4400
	4T-623/612	120,650	41,275	31,750	41,275	3,5	3,3	2,120	172,00	213,00	3300	4400
	4T-78225/78551	140,030	33,236	23,520	36,512	3,5	2,3	2,690	171,00	212,00	2600	3400
59,987	4T-H913840/H913810	146,050	39,688	25,400	41,275	3,5	3,3	3,220	199,00	234,00	2400	3200
60,000	4T-JLM508748/JLM508710	95,000	24,000	19,000	24,000	5,0	2,5	0,606	83,00	122,00	3700	4900

Zöllige Abmessungen

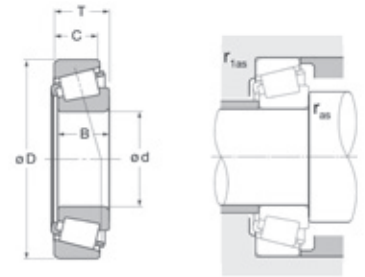

Innendurchmesser	NTN-Bezeichnung	Außendurchmesser	Innenringbreite	Außenringbreite	Gesamtbreite	Max. Radius an der Welle	Max. Radius am Gehäuse	Gewicht	Dynamische Tragzahl C	Statische Tragzahl C0	Grenzdrehzahl mit Fett	Grenzdrehzahl mit Öl
(d)		(D)	(B)	(C)	(T)	(r_{as} max)	(r_{1as} max)					
mm		mm						kg	kN		U/min	
60,325	4T-28985/28921	100,000	25,400	19,845	25,400	3,5	3,3	0,772	90,50	134,00	3500	4700
	4T-28985/28920	101,600	25,400	19,845	25,400	3,5	3,3	0,811	90,50	134,00	3500	4700
	4T-3980/3920	112,712	30,048	23,812	30,162	3,5	3,3	1,330	119,00	174,00	3200	4300
	4T-65237/65500	127,000	44,450	34,925	44,450	3,5	3,3	2,650	203,00	263,00	3100	4200
	4T-HM911245/HM911210	130,175	33,338	23,812	36,512	5,0	3,3	2,120	156,00	186,00	2700	3600
	4T-78238/78537	136,525	33,236	23,520	36,513	5,0	3,3	2,330	171,00	212,00	2600	3400
61,912	4T-H715334/H715311	136,525	46,038	36,512	46,038	3,5	3,3	3,470	224,00	355,00	2600	3500
	4T-H913842/H913810	146,050	39,688	25,400	41,275	3,5	3,3	3,170	199,00	234,00	2400	3200
62,738	4T-28995/28921	100,000	25,400	19,845	25,400	3,5	3,3	0,700	90,50	134,00	3500	4700
63,500	4T-L610549/L610510	94,458	19,050	15,083	19,050	1,5	1,5	0,449	60,50	103,00	3600	4800
	4T-39250/39412	104,775	22,000	15,875	21,433	2,0	2,0	0,680	83,50	108,00	3400	4500
	4T-29585/29520	107,950	25,400	19,050	25,400	3,5	3,3	0,924	91,50	140,00	3200	4300
	4T-29586/29520	107,950	25,400	19,050	25,400	1,5	3,3	0,929	91,50	140,00	3200	4300
	4T-390A/394A	110,000	21,996	18,824	22,000	1,5	1,3	0,851	89,50	120,00	3200	4300
	4T-395/394A	110,000	21,996	18,824	22,000	3,5	1,3	0,847	89,50	120,00	3200	4300
	4T-29585/29521	110,000	25,400	19,050	25,400	3,5	1,3	0,982	91,50	140,00	3200	4300
	4T-3982/3920	112,712	30,048	23,812	30,162	3,5	3,3	1,260	119,00	174,00	3200	4300
	4T-39585/39520	112,712	30,162	23,812	30,162	3,5	3,3	1,270	138,00	195,00	3200	4200
	4T-HM212047/HM212011	122,238	38,354	29,718	38,100	7,0	3,3	1,940	187,00	244,00	3100	4100
	4T-5584/5535	122,238	43,764	36,512	43,658	3,5	3,3	2,340	194,00	283,00	3100	4100
	4T-559/552A	123,825	36,678	30,162	38,100	3,5	3,3	2,010	158,00	216,00	3000	4100
	4T-639/632	136,525	41,275	31,750	41,275	3,5	3,3	2,850	194,00	262,00	2800	3800
4T-78250/78551	140,030	33,236	23,520	36,512	2,3	2,3	2,540	171,00	212,00	2600	3400	
65,000	4T-JLM710949/JLM710910	105,000	23,000	18,500	24,000	3,0	1,0	0,742	85,00	117,00	3300	4500
	4T-JLM710949/JLM710910PK	105,000	23,000	18,500	24,000	3,0	1,0	0,742	85,00	117,00	3300	4500
	4T-JM511946/JM511910	110,000	28,000	22,500	28,000	3,0	2,5	1,080	119,00	174,00	3200	4300
	4T-JM511946/JM511910PK	110,000	28,000	22,500	28,000	3,0	2,5	1,050	119,00	174,00	3200	4300
	4T-JH211749/JH211710PK	120,000	38,500	32,000	39,000	3,0	2,5	1,860	185,00	248,00	3100	4100
65,088	4T-6379/6320	135,755	56,007	44,450	53,975	3,5	3,3	3,710	278,00	380,00	2900	3800
65,987	4T-H212749/H212710	123,975	41,500	34,000	41,500	7,0	3,5	2,130	205,00	277,00	3000	4000

Zöllige Abmessungen

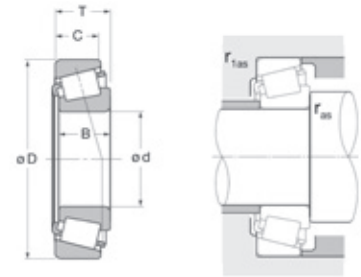

Innendurchmesser	NTN-Bezeichnung	Außendurchmesser	Innenringbreite	Außenringbreite	Gesamtbreite	Max. Radius an der Welle	Max. Radius am Gehäuse	Gewicht	Dynamische Tragzahl C	Statische Tragzahl C0	Grenzdrehzahl mit Fett	Grenzdrehzahl mit Öl
(d)		(D)	(B)	(C)	(T)	(r _{as max})	(r _{1as max})					
mm		mm						kg	kN		U/min	
66,675	4T-29590/29520	107,950	25,400	19,050	25,400	3,5	3,3	0,860	91,50	140,00	3200	4300
	4T-29590/29522	107,950	25,400	19,050	25,400	3,5	0,8	0,860	91,50	140,00	3200	4300
	4T-395A/394A	110,000	21,996	18,824	22,000	0,8	1,3	0,796	89,50	120,00	3200	4300
	4T-395S/394A	110,000	21,996	18,824	22,000	3,5	1,3	0,791	89,50	120,00	3200	4300
	4T-395A/394	110,000	21,996	22,000	22,000	0,8	0,8	0,830	89,50	120,00	3200	4300
	4T-29590/29521	110,000	25,400	19,050	25,400	3,5	1,3	0,910	91,50	140,00	3200	4300
	4T-3984/3920	112,712	30,048	23,812	30,162	3,5	3,3	1,180	119,00	174,00	3200	4300
	4T-3994/3920	112,712	30,048	23,812	30,162	5,5	3,3	1,180	119,00	174,00	3200	4300
	4T-39590/39520	112,712	30,162	23,812	30,162	3,5	3,3	1,190	138,00	195,00	3200	4200
	4T-HM212049/HM212010	122,238	38,354	29,718	38,100	3,5	1,5	1,860	187,00	244,00	3100	4100
	4T-HM212049/HM212011	122,238	38,354	29,718	38,100	3,5	3,3	1,850	187,00	244,00	3100	4100
	4T-6386/6320	135,755	56,007	44,450	53,975	4,3	3,3	3,640	278,00	380,00	2900	3800
	4T-641/632	136,525	41,275	31,750	41,275	3,5	3,3	2,740	194,00	262,00	2800	3800
	4T-H414242/H414210	136,525	41,275	31,750	41,275	3,5	3,3	2,750	226,00	293,00	2700	3700
	4T-H715341A/H715311	136,525	46,038	36,512	46,038	7,0	3,3	3,280	224,00	355,00	2600	3500
68,262	4T-399A/394A	110,000	21,996	18,824	22,000	2,3	1,3	0,764	89,50	120,00	3200	4300
	4T-399AS/394A	110,000	21,996	18,824	22,000	5,0	1,3	0,756	89,50	120,00	3200	4300
	4T-H414245/H414210	136,525	41,275	31,750	41,275	3,5	3,3	2,700	226,00	293,00	2700	3700
	4T-H715343/H715311	136,525	46,038	36,512	46,038	3,5	3,3	3,240	224,00	355,00	2600	3500
	4T-9278/9220	161,925	46,038	31,750	49,212	3,5	3,3	4,640	255,00	300,00	2400	2900
69,850	4T-L713049/L713010	101,600	19,050	15,083	19,050	1,5	1,5	0,510	60,50	106,00	3300	4400
	4T-29675/29620	112,712	25,400	19,050	25,400	1,5	3,3	0,949	95,50	151,00	3100	4100
	4T-33275/33462	117,475	30,162	23,812	30,162	3,5	3,3	1,280	117,00	175,00	3000	4000
	4T-482/472	120,000	29,007	24,237	29,794	3,5	2,0	1,330	128,00	177,00	3000	4000
	4T-47487/47420	120,000	32,545	26,195	32,545	3,5	3,3	1,470	147,00	214,00	3000	4000
	4T-643/632	136,525	41,275	31,750	41,275	3,5	3,3	2,630	194,00	262,00	2800	3800
	4T-H913849/H913810	146,050	39,688	25,400	41,275	3,5	3,3	2,850	199,00	234,00	2700	3200
	4T-655/653	146,050	41,275	31,750	41,275	3,5	3,3	3,280	206,00	295,00	2500	3300
	4T-745A/742	150,089	46,672	36,512	44,450	3,5	3,3	3,920	261,00	360,00	2400	3200
	4T-835/832	168,275	56,363	41,275	53,975	3,5	3,3	6,130	340,00	460,00	2200	3000
69,987	4T-H715347/H715311	136,525	46,038	36,512	46,038	3,5	3,3	3,170	224,00	355,00	2600	3500
70,000	4T-JLM813049/JLM813010PK	110,000	25,000	20,500	26,000	1,0	2,5	0,889	97,00	150,00	3200	4200
	4T-JM612949/JM612910PK	115,000	29,000	23,000	29,000	3,0	2,5	1,130	124,00	171,00	3100	4100
71,438	4T-33281/33462	117,475	30,162	23,812	30,162	3,5	3,3	1,240	117,00	175,00	3000	4000
	4T-33281/33472	120,000	30,162	23,444	29,794	3,5	0,8	1,300	117,00	175,00	3000	4000
	4T-47490/47420	120,000	32,545	26,195	32,545	3,5	3,3	1,420	147,00	214,00	3000	4000
	4T-567A/563	127,000	36,170	28,575	36,512	3,5	3,3	1,870	163,00	229,00	2900	3800
	4T-HM813849/HM813810	127,000	36,512	26,988	36,512	3,5	3,3	1,870	163,00	228,00	2900	3800
	4T-645/632	136,525	41,275	31,750	41,275	6,4	3,3	2,530	194,00	262,00	2800	3800
	4T-H414249/H414210	136,525	41,275	31,750	41,275	3,5	3,3	2,580	226,00	293,00	2700	3700
	4T-H715345/H715311	136,525	46,038	36,512	46,038	3,5	3,3	3,110	224,00	355,00	2600	3500

Zöllige Abmessungen

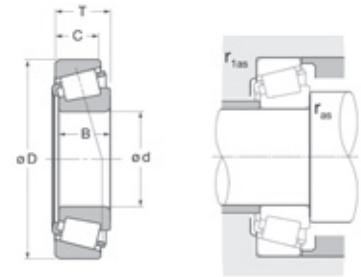

Innendurchmesser	NTN-Bezeichnung	Außendurchmesser	Innenringbreite	Außenringbreite	Gesamtbreite	Max. Radius an der Welle	Max. Radius am Gehäuse	Gewicht	Dynamische Tragzahl C	Statische Tragzahl C0	Grenzdrehzahl mit Fett	Grenzdrehzahl mit Öl
(d)		(D)	(B)	(C)	(T)	(r _{as} max)	(r _{1.25} max)	kg	kN		U/min	
mm		mm						kg	kN		U/min	
73,025	4T-29685/29620	112,712	25,400	19,050	25,400	3,5	3,3	0,873	95,50	151,00	3100	4100
	4T-33287/33462	117,475	30,162	23,812	30,162	3,5	3,3	1,190	117,00	175,00	3000	4000
	4T-6460/6420	149,225	54,229	44,450	53,975	3,5	3,3	4,420	287,00	410,00	2500	3400
73,817	4T-29688/29620	112,712	25,400	19,050	25,400	1,5	3,3	0,860	95,50	151,00	3100	4100
75,000	4T-JLM714149/JLM714110PK	115,000	25,000	19,000	25,000	3,0	2,5	0,875	94,50	143,00	3000	4000
	4T-JM714249/JM714210PK	120,000	29,500	25,000	31,000	3,0	2,5	1,300	131,00	197,00	2900	3900
	4T-JH415647/JH415610PK	140,000	51,000	42,000	51,000	3,0	2,5	3,810	287,00	410,00	2500	3400
	4T-JH415647/JH415610	145,000	51,000	42,000	51,000	3,0	2,5	3,810	287,00	410,00	2500	3400
75,987	4T-HM215249/HM215210	131,976	39,000	32,000	39,000	7,0	3,5	2,110	197,00	281,00	2700	3600
76,200	4T-L814749/L814710	109,538	19,050	15,083	19,050	1,5	1,5	0,579	63,00	115,00	3100	4100
	4T-34300/34478	121,442	23,012	17,462	24,608	2,0	2,0	0,982	91,00	127,00	2900	3800
	4T-34301/34478	121,442	23,012	17,462	24,608	3,5	2,0	0,977	91,00	127,00	2900	3800
	4T-42687/42620	127,000	31,000	22,225	30,162	3,5	3,3	1,460	135,00	194,00	2800	3700
	4T-47679/47620	133,350	33,338	26,195	33,338	3,5	3,3	1,930	153,00	235,00	2600	3500
	4T-575/572	139,992	36,098	28,575	36,512	3,5	3,3	2,430	178,00	265,00	2600	3400
	4T-575/572X	139,700	36,098	28,575	36,512	3,5	3,3	2,430	178,00	265,00	2600	3400
	4T-HM515745/HM515716	142,138	46,100	33,338	44,450	3,5	3,3	2,860	200,00	278,00	2600	3500
	4T-748S/742	150,089	46,672	36,512	44,450	3,5	3,3	3,660	261,00	360,00	2400	3200
	4T-9285/9220ST	161,925	46,038	31,750	49,212	3,5	3,3	4,310	255,00	300,00	2400	2900
	4T-9378/9321	171,450	50,800	31,750	49,212	3,5	3,3	5,350	265,00	325,00	2200	2700
4T-H917840/H917810	180,975	53,183	35,720	53,975	3,5	3,3	6,570	325,00	415,00	1900	2600	
77,788	4T-LM814849/LM814810	117,475	25,400	19,050	25,400	3,5	3,3	0,932	99,50	162,00	2900	3900
	4T-34306/34478	121,442	23,012	17,462	24,608	3,5	2,0	0,943	91,00	127,00	2900	3800
	4T-34306/34500	127,000	23,012	19,842	26,987	3,5	3,3	1,130	91,00	127,00	2900	3800
	4T-42690/42620	127,000	31,000	22,225	30,162	3,5	3,3	1,410	135,00	194,00	2800	3700
	4T-H715348/H715311	136,525	46,038	36,512	46,038	3,5	3,3	2,840	224,00	355,00	2600	3500
79,974	4T-HM218238/HM218210	146,975	40,000	32,500	40,000	7,0	3,5	2,990	227,00	340,00	2400	3200
80,000	4T-JM515649/JM515610PK	130,000	34,000	28,500	35,000	3,0	2,5	1,710	166,00	249,00	2700	3600
80,962	4T-581/572	139,992	36,098	28,575	36,512	3,5	3,3	2,260	178,00	265,00	2600	3400
82,550	4T-L116149/L116110PX2	115,888	21,433	16,670	20,637	1,5	1,5	0,670	78,00	133,00	2900	3800
	4T-27687/27620	125,412	25,400	19,845	25,400	3,5	1,5	1,070	102,00	163,00	2700	3600
	4T-495/492A	133,350	29,769	22,225	30,163	3,5	3,3	1,490	129,00	189,00	2600	3500
	4T-47686/47620	133,350	33,338	26,195	33,338	3,5	3,3	1,720	153,00	235,00	2600	3500
	4T-580/572	139,992	36,098	28,575	36,512	3,5	3,3	2,200	178,00	265,00	2600	3400
	4T-663/653	146,050	41,275	31,750	41,275	3,5	3,3	2,780	206,00	295,00	2500	3300
	4T-749A/742	150,089	46,672	36,512	44,450	3,5	3,3	3,370	261,00	360,00	2400	3200
4T-842/832	168,275	56,363	41,275	53,975	3,5	3,3	5,460	340,00	460,00	2200	3000	

Zöllige Abmessungen

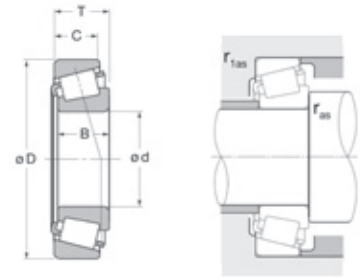

Innendurchmesser (d)	NTN-Bezeichnung	Außendurchmesser (D)	Innenringbreite (B)	Außenringbreite (C)	Gesamtbreite (T)	Max. Radius an der Welle (r _{as} max)	Max. Radius am Gehäuse (r _{1.25} max)	Gewicht	Dynamische Tragzahl C	Statische Tragzahl C ₀	Grenzdrehzahl mit Fett	Grenzdrehzahl mit Öl
mm		mm						kg	kN		U/min	
83,345	4T-27690/27620	125,412	25,400	19,845	25,400	3,5	1,5	1,050	102,00	163,00	2700	3600
84,976	4T-27695/27620	125,412	25,400	19,845	25,400	5,0	1,5	0,960	102,00	163,00	2700	3600
85,000	4T-JM716649/JM716610	130,000	29,000	24,000	30,000	3,0	2,5	1,390	135,00	214,00	2600	3500
	4T-JM716648/JM716610PK	130,000	29,000	24,000	30,000	6,0	2,5	1,320	135,00	214,00	2600	3500
	4T-JM716649/JM716610PK	130,000	29,000	24,000	30,000	3,0	2,5	1,350	135,00	214,00	2600	3500
85,026	4T-749/742	150,089	46,672	36,512	44,450	3,5	3,3	3,250	261,00	360,00	2400	3200
85,725	4T-497/492A	133,350	29,769	22,225	30,162	3,5	3,3	1,430	129,00	189,00	2600	3500
	4T-497/493	136,525	29,769	22,225	30,162	3,5	3,3	1,550	129,00	189,00	2600	3500
	4T-665/653	146,050	41,275	31,750	41,275	3,5	3,3	2,650	206,00	295,00	2500	3300
88,900	4T-L217849/L217810	123,825	20,638	16,670	20,638	1,5	1,5	0,737	80,00	141,00	2700	3500
	4T-42350/42584	148,430	28,971	21,433	28,575	3,0	3,0	1,960	138,00	215,00	2300	3100
	4T-HM518445/HM518410	152,400	39,688	30,162	39,688	6,4	3,3	2,810	252,00	365,00	2300	3100
	4T-759/752	161,925	48,260	38,100	47,625	3,5	3,3	4,090	270,00	385,00	2300	3100
	4T-6580/6535V1	161,925	55,100	42,862	53,974	3,5	3,3	4,670	310,00	460,00	2300	3000
	4T-6580/6535	161,925	55,100	42,862	53,975	3,5	3,3	4,730	310,00	460,00	2300	3000
	4T-850/832	168,275	56,363	41,275	53,975	3,5	3,3	5,080	340,00	460,00	2200	3000
4T-98350/98788	200,000	49,212	34,925	52,761	3,5	3,3	7,550	345,00	470,00	1900	2500	
89,974	4T-HM218248/HM218210	146,975	40,000	32,500	40,000	7,0	3,5	2,550	227,00	340,00	2400	3200
90,000	4T-JM718149/JM718110PK	145,000	34,000	27,000	35,000	3,0	2,5	2,140	189,00	279,00	2400	3200
	4T-JHM318448/JHM318410	155,000	44,000	35,500	44,000	3,0	2,5	3,320	270,00	385,00	2300	3100
	4T-6581X/6525X	160,000	55,100	44,450	53,975	3,0	3,0	4,470	310,00	460,00	2300	3000
92,075	4T-47890/47820	146,050	34,925	26,195	33,338	3,5	3,3	2,080	163,00	266,00	2400	3100
	4T-598A/592A	152,400	36,322	30,162	39,688	6,4	3,3	2,630	180,00	279,00	2300	3100
95,000	4T-JL819349/JL819310	135,000	20,000	14,000	20,000	5,0	2,5	0,840	76,50	129,00	2500	3300
	4T-JM719149/JM719113	150,000	34,000	27,000	35,000	3,0	2,5	2,190	180,00	279,00	2300	3100
95,250	4T-LL319349/LL319310	128,587	15,083	11,908	15,875	1,5	1,5	0,530	61,00	99,00	2500	3400
	4T-L319249/L319210	130,175	21,433	16,670	20,638	1,5	1,5	0,789	81,00	147,00	2500	3300
	4T-47896/47820	146,050	34,925	26,195	33,338	3,5	3,3	1,950	163,00	266,00	2400	3100
	4T-42375/42584	148,430	28,971	21,433	28,575	3,0	3,0	1,750	138,00	215,00	2300	3100
	4T-594/593X	150,000	36,322	27,000	35,992	3,5	3,0	2,200	174,00	267,00	2300	3100
	4T-594/592A	152,400	36,322	30,162	39,688	3,5	3,3	2,510	180,00	279,00	2300	3100
	4T-594A/592A	152,400	36,322	30,162	39,688	5,0	3,3	2,510	180,00	279,00	2300	3100
4T-683/672	168,275	41,275	30,162	41,275	3,5	3,3	3,720	222,00	340,00	2100	2800	
96,838	4T-42381/42584	148,430	28,971	21,433	28,575	3,5	3,0	1,690	138,00	215,00	2300	3100
	4T-90381/90744	188,912	46,038	31,750	50,800	3,5	3,3	5,670	281,00	365,00	1800	2400

Zöllige Abmessungen

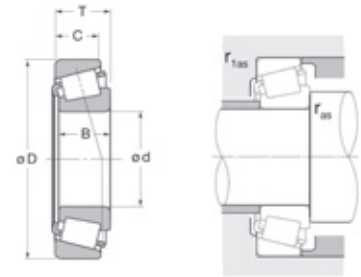

Innendurchmesser (d)	NTN-Bezeichnung	Außendurchmesser (D)	Innenringbreite (B)	Außenringbreite (C)	Gesamtbreite (T)	Max. Radius an der Welle (r ₂₅ max)	Max. Radius am Gehäuse (r _{1.25} max)	Gewicht	Dynamische Tragzahl C	Statische Tragzahl C ₀	Grenzdrehzahl mit Fett	Grenzdrehzahl mit Öl
mm		mm						kg	kN		U/min	
98,425	4T-52387/52618	157,162	36,116	26,195	36,512	3,5	3,3	2,620	188,00	305,00	2200	2900
99,974	4T-HM220149/HM220110	156,975	42,000	34,000	42,000	8,0	3,5	2,820	248,00	380,00	2200	2900
100,000	4T-JM720249/JM720210	155,000	35,000	28,000	36,000	3,0	2,5	2,400	192,00	310,00	2200	2900
	4T-JHM720249/JHM720210	160,000	40,000	32,000	41,000	3,0	2,5	3,040	235,00	370,00	2200	2900
100,012	4T-52393/52618	157,162	36,116	26,195	36,512	3,5	3,3	2,550	188,00	305,00	2200	2900
101,600	4T-L420449/L420410	136,525	21,433	16,670	21,433	1,5	1,5	0,850	85,00	159,00	2400	3200
	4T-52401/52618	157,162	36,116	26,195	36,512	8,0	3,3	2,410	188,00	300,00	2200	2900
	4T-52400/52618	157,162	36,116	26,195	36,512	3,5	3,3	2,480	188,00	305,00	2200	2900
	4T-687/672	168,275	41,275	30,162	41,275	3,5	3,3	3,400	222,00	340,00	2100	2800
	4T-780/772	180,975	48,006	38,100	47,625	3,5	3,3	5,110	285,00	430,00	2000	2700
	4T-HH221449/HH221410	190,500	57,531	46,038	57,150	8,0	3,3	7,060	445,00	610,00	1900	2600
	4T-98400/98788	200,000	49,212	34,925	52,761	3,5	3,3	6,820	345,00	470,00	1900	2500
	4T-HH224335/HH224310	212,725	66,675	53,975	66,675	7,0	3,3	11,300	575,00	810,00	1700	2300
4T-HH923649/HH923610	250,825	73,025	50,800	76,200	6,4	6,4	17,480	590,00	750,00	1600	1900	
104,775	4T-782/772	180,975	48,006	38,100	47,625	3,5	3,3	4,920	285,00	430,00	2000	2700
106,362	4T-56418/56650	165,100	36,512	26,988	36,512	3,5	3,3	2,700	191,00	315,00	2100	2700
107,950	4T-37425/37625	158,750	21,438	15,875	23,020	3,5	3,3	1,370	102,00	166,00	2100	2800
	4T-48190/48120	161,925	34,925	26,988	34,925	3,5	3,3	2,340	159,00	266,00	2100	2800
	4T-56426/56650	165,100	36,512	26,988	36,512	8,0	3,3	2,550	191,00	315,00	2100	2700
	4T-56425/56650	165,100	36,512	26,988	36,512	3,5	3,3	2,690	191,00	315,00	2100	2700
	4T-936/932	212,725	66,675	53,975	66,675	8,0	3,3	10,700	475,00	695,00	1800	2300
109,538	4T-37431/37625	158,750	21,438	15,875	23,020	3,5	3,3	1,330	102,00	166,00	2100	2800
	4T-37431A/37625	158,750	21,438	15,875	23,020	5,1	3,3	1,330	102,00	166,00	2100	2800
109,974	4T-64432/64708	179,974	41,275	30,162	41,275	3,5	3,3	3,850	232,00	375,00	1900	2600
109,987	4T-LM522548/LM522510	159,987	34,925	26,988	34,925	8,0	3,3	2,240	167,00	320,00	2100	2800
	4T-LM522549/LM522510	159,987	34,925	26,988	34,925	3,5	3,3	2,270	167,00	320,00	2100	2800
110,000	4T-JM822049/JM822010	165,000	35,000	26,500	35,000	3,0	2,5	2,520	191,00	315,00	2100	2700
	4T-JM822049/JM822010PK	165,000	35,000	26,500	35,000	3,0	2,5	2,460	191,00	315,00	2100	2700
	4T-JHM522649/JHM522610	180,000	46,000	38,000	47,000	3,0	2,5	4,610	305,00	480,00	1900	2600
111,125	4T-H924045/H924010	214,312	52,388	39,688	55,562	3,5	3,3	8,180	405,00	560,00	1500	2000
	4T-H924045/H924010D	214,312	52,388	84,138	115,887	3,5	1,5	11,880	695,00	1120,00	1500	2000

Zöllige Abmessungen

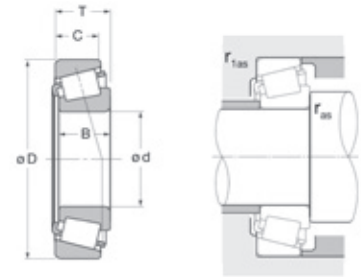

Innendurchmesser (d) mm	NTN-Bezeichnung	Außendurchmesser (D)	Innenringbreite (B)	Außenringbreite (C)	Gesamtbreite (T)	Max. Radius an der Welle (r _{as} max)	Max. Radius am Gehäuse (r _{1.25} max)	Gewicht kg	Dynamische Tragzahl C	Statische Tragzahl C ₀	Grenzdrehzahl mit Fett U/min	Grenzdrehzahl mit Öl U/min
114,300	4T-64450/64700	177,800	41,275	30,162	41,275	3,5	3,3	3,520	232,00	375,00	1900	2600
	4T-71450/71750	190,500	49,212	34,925	47,625	3,5	3,3	5,150	300,00	475,00	1800	2500
	4T-938/932	212,725	66,675	53,975	66,675	7,0	3,3	10,100	475,00	695,00	1800	2300
	4T-HM926740/HM926710	228,600	49,428	38,100	53,975	3,5	3,3	9,760	430,00	620,00	1400	1900
114,976	4T-HH224349/HH224310V2	212,725	66,675	53,975	66,675	7,0	3,3	10,370	575,00	810,00	1700	2300
117,475	4T-68462/68712	180,975	31,750	25,400	34,925	3,5	3,3	2,780	169,00	245,00	1900	2500
120,650	4T-L624549/L624510	160,338	21,433	16,670	21,433	1,5	1,5	1,160	92,50	188,00	2000	2700
	4T-HH228340/HH228310	254,000	82,550	61,912	77,788	9,7	6,4	19,420	740,00	1070,00	1400	1900
	4T-HH228340/HH228310V1	254,000	82,550	61,912	77,788	9,7	6,4	19,420	740,00	1070,00	1400	1900
	4T-HH228340/HH228310V3	254,000	82,550	61,912	77,788	9,7	6,4	19,420	740,00	1070,00	1400	1900
	4T-HH228340/HH228318V4	254,000	82,550	61,912	77,788	9,7	6,4	19,420	740,00	1070,00	1400	1900
123,825	4T-48286/48220	182,562	38,100	33,338	39,688	3,5	3,3	3,520	224,00	435,00	1800	2400
125,298	4T-HM926745/HM926710	228,600	49,428	38,100	53,975	3,5	3,3	8,870	430,00	620,00	1400	1900
127,000	4T-LL225749/LL225710	165,895	17,462	13,495	18,257	1,5	1,5	0,920	81,50	144,00	1900	2500
	4T-L225849/L225810	169,862	26,195	20,638	25,400	1,5	1,5	1,610	123,00	246,00	1900	2500
	4T-48290/48220	182,562	38,100	33,338	39,688	3,5	3,3	3,330	224,00	435,00	1800	2400
	4T-67388/67322	196,850	46,038	38,100	46,038	3,5	3,3	5,100	310,00	550,00	1700	2200
	4T-95500/95925	234,950	63,500	49,212	63,500	6,4	3,3	12,000	525,00	825,00	1500	2000
	4T-HH228349/HH228310	254,000	82,550	61,912	77,788	9,7	6,4	19,500	740,00	1070,00	1400	1900
133,350	4T-L327249/L327210	177,008	26,195	20,638	25,400	1,5	1,5	1,700	126,00	259,00	1800	2400
	4T-48385/48320	190,500	39,688	33,338	39,688	3,5	3,3	3,640	236,00	475,00	1700	2300
	4T-67390/67322	196,850	46,038	38,100	46,038	3,5	3,3	4,630	310,00	550,00	1700	2200
	4T-95525/95925	234,950	63,500	49,212	63,500	9,7	3,3	11,300	525,00	825,00	1500	2000
136,525	4T-48393/48320	190,500	39,688	33,338	39,688	3,5	3,3	3,430	236,00	475,00	1700	2300
139,700	4T-898/892	228,600	57,150	44,450	57,150	3,5	3,3	8,760	445,00	735,00	1500	2000
142,875	4T-48685/48620	200,025	39,688	34,130	41,275	3,5	3,3	3,890	239,00	490,00	1600	2100
146,050	4T-36690/36620	193,675	28,575	23,020	28,575	1,5	1,5	2,270	165,00	340,00	1600	2200
152,400	4T-M231649/M231610	222,250	46,830	34,925	46,830	3,5	1,5	5,770	315,00	585,00	1500	2000
	4T-99600/99100	254,000	66,675	47,625	66,675	7,0	3,3	12,470	550,00	910,00	1400	1800
158,750	4T-L433749/L433710	205,580	23,810	18,260	23,810	1,5	1,5	1,890	126,00	247,00	1500	2000
	4T-L432349/L432310	205,583	23,812	18,258	23,812	1,5	1,5	1,890	126,00	247,00	1500	2000

Zöllige Abmessungen

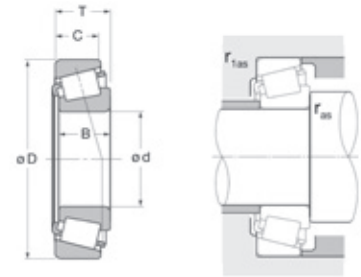

Innendurchmesser (d) mm	NTN-Bezeichnung	Außendurchmesser (D)	Innenringbreite (B)	Außenringbreite (C)	Gesamtbreite (T)	Max. Radius an der Welle (r_{as} max)	Max. Radius am Gehäuse ($r_{1.25}$ max)	Gewicht kg	Dynamische Tragzahl C kN	Statische Tragzahl C0 kN	Grenzdrehzahl mit Fett U/min	Grenzdrehzahl mit Öl U/min
170,000	4T-JHM534149/JHM534110PK	230,000	38,000	31,000	39,000	3,0	2,5	4,320	282,00	520,00	1400	1800
	4T-JM734449/JM734410	240,000	44,500	37,000	46,000	3,0	2,5	6,280	325,00	590,00	1300	1800
174,625	4T-67787/67720	247,650	47,625	38,100	47,625	3,5	3,3	6,960	340,00	690,00	1300	1700
177,800	4T-36990/36920	227,012	30,162	23,020	30,162	1,5	1,5	2,920	181,00	415,00	1300	1800
	4T-67790/67720	247,650	47,625	38,100	47,625	3,5	3,3	6,570	340,00	690,00	1300	1700
	4T-M236849/M236810	260,350	53,975	41,275	53,975	3,5	3,3	9,050	445,00	825,00	1200	1700
180,000	4T-JM736149/JM736110	250,000	45,000	37,000	47,000	3,0	2,5	6,760	370,00	710,00	1300	1700
187,325	4T-M238849/M238810	269,875	55,562	42,862	55,563	3,5	3,3	9,880	460,00	875,00	1200	1600
190,000	4T-JM738249/JM738210	260,000	44,000	36,500	46,000	3,0	2,5	6,850	365,00	720,00	1200	1600
	4T-JM738249/JM738210PK	260,000	44,000	36,500	46,000	3,0	2,5	6,870	365,00	720,00	1200	1600
196,850	4T-LL639249/LL639210	241,300	23,017	17,462	23,812	1,5	1,5	2,070	160,00	330,00	1200	1600

Experts & Tools Services

Montage- und Demontagewerkzeuge

Einbau, Ausbau und Kontrolle von Wälzlagern: Wichtige Werkzeuge, die die Lebensdauer eines Systems und dessen einwandfreien Betrieb maßgeblich beeinflussen.



Kaltmontage

Der Werkzeugkoffer für den schnellen, sicheren und präzisen Wälzlagereinbau.



Warmmontage

Bei der Warmmontage wird die Temperatur des Wälzlagers erhöht, wodurch sich der Lagerinnenring aufweitet und leichter über die Welle auf den Lagersitz geführt werden kann.

Erwärmung durch Induktion: die praktische, einfache, sichere und umweltfreundliche Lösung!



Montagepaste

Die NTN-SNR Montagepaste wurde eigens entwickelt, um Kontaktkorrosion zwischen den Passflächen vorzubeugen.



Ausbauwerkzeuge

a. Manueller selbstzentrierender Abzieher mit zwei oder drei Abzugshaken

Eine Baureihe leistungsstarker Abzieher für den leichten und gefahrlosen Ausbau von Wälzlagern oder anderen Bauteilen mit Presssitz.

b. Innenauszieher-Werkzeugsätze

Innenauszieher mit Spindel für das Abziehen über die Bohrung. Für den einfachen und schnellen Ausbau von Wälzlagern mit Presssitz im Gehäuse.

c. Dreiteilige universelle Trennvorrichtung

Ein fester Griff für einen sicheren und wirksamen Ausbau mit dem mechanischen oder hydraulischen Abzieher.



Messgeräte

Einfache, sichere und präzise Überwachung der Maschinenbetriebstemperatur mit einem Infrarot-Thermometer mit Laserabtastung.

Sowie viele weitere Werkzeuge für Lagermontage und Handhabung...

Schmierung: Die passende Lösung für jede Anwendung

Wir unterstützen Sie bei Ihren Projekten zur Nachschmierung: von der Auslegung bis zur Inbetriebnahme. Wir bieten Ihnen speziell für Ihre Anwendungen ausgewählte Schmierstoffe, sowie Einpunkt- oder Mehrpunkt-Schmiersysteme entsprechend Ihrer Anwendung und Anforderungen.



Schmierstoffe

Diese Fette und Öle sind auf die speziellen Anforderungen Ihrer Anwendungen ausgelegt und gewährleisten einen optimalen Betrieb der Wälzlager.



Universal



Heavy Duty



Vib



High Temp



Ultra High Temp



Food AL



High Speed+



Food Chain Oil



Chain Oil



Automatische Einpunkt-Schmiersysteme

Die automatische Einpunkt-Schmiersysteme gewährleisten eine konstante und regelmäßige Schmierung.

Diese Systeme lassen sich einfach in unterschiedliche Anwendungen integrieren (Maschinenbau, Automobilbau, Stahlverarbeitung, Papierfabriken usw.) und dienen der Verbesserung der Schmierung ohne Änderung der vorhandenen Bauteile oder Installationen.



Mehrpunkt-Schmiersystem: POLIPUMP

POLIPUMP ist das ideale System zur Schmierung mehrerer Schmierpunkte. Das System ist mit 12, 24 oder 35 Ausgängen lieferbar. Es ist mit einem großen Vorratsbehälter ausgerüstet und ermöglicht unabhängige Abgabemengen zwischen 0,02 und 0,13 cm³ je Zyklus für jeden Schmierpunkt bei einem maximalen Druck von bis zu 80 bar. POLIPUMP ist ein weit verbreitetes System, das sehr einfach in der Handhabung ist.



Auslegung und Einrichtung von Schmiersystemen

Die Fachleute von LUB'SOLUTIONS unterstützen Ihre Projekte von der Auslegung bis zur Einrichtung.

Wenden Sie sich mit diesen Anfragen direkt an NTN-SNR Experts & Tools (Tel. +49 (0) 521 92400 111, E-Mail: service.germany@ntn-snr.de), oder setzen Sie sich über Ihren NTN-SNR Partner mit uns in Verbindung.

Services

Die Fachleute von NTN-SNR stehen Ihnen bei allen Fragen rund um die Auslegung und den Betrieb Ihrer Wälzlager zur Verfügung.



Schulung

Vom Vertrieb bis zur Wartung: Wir bieten Seminare über ein breites Spektrum an – ob Lagerauswahl oder Lagerwartung. NTN-SNR führt Seminare im eigenen Ausbildungszentrum oder auf Wunsch vor Ort mit der „BEARING BOX“ durch. Die Seminare können individuell auf den jeweiligen Bedarf zu Theorie und Praxis abgestimmt werden.



Wälzlagerdiagnose

Die Fachleute von NTN-SNR unterstützen Sie bei der Analyse von Wälzlagern: in unserem Labor oder bei Ihnen vor Ort. Empfehlungen von unseren qualifizierten Wälzlagerexperten helfen, die Leistung Ihrer Anwendungen zu steigern.



Technische Unterstützung für Wälzlagermontagen und -demontagen

Unsere Fachleute von Experts & Tools leisten Hilfestellung bei Wartungsarbeiten (Ein- und Ausbau von Wälzlagern, Wellenausrichtung mit Lasertechnologie usw.).



Werkzeugverleih

Bei uns können Sie die passenden Werkzeuge mieten. Ob Induktionsanwärmegeräte oder Hydraulikmuttern für den Lagereinbau. So haben Sie die richtigen Werkzeuge für eine fachgerechte Ausführung der Arbeiten zur Hand.



KEGELROLLENLAGER

Das vorliegende Dokument ist das alleinige Eigentum von NTN-SNR ROULEMENTS. Jegliche vollständige oder teilweise Reproduktion ohne vorherige Genehmigung durch NTN-SNR ROULEMENTS ist ausdrücklich verboten. Bei einem Verstoß gegen diesen Absatz können Sie strafrechtlich verfolgt werden.

Für Fehler oder Auslassungen, die sich trotz aller Sorgfalt bei der Erstellung in das Dokument eingeschlichen haben könnten, lehnt NTN-SNR ROULEMENTS jede Haftung ab.

Aufgrund unserer kontinuierlichen Forschungs- und Entwicklungspolitik behalten wir uns vor, einzelne oder alle der in diesem Dokument dargestellten Produkte und Spezifikationen ohne Vorankündigung zu ändern.

© NTN-SNR ROULEMENTS, Internationales Copyright 2017.

NTN-SNR ROULEMENTS - 1 rue des Usines - 74000 Annecy
RCS ANNECY B 325 821 072 - Code APE 2815Z - Code NACE 28.15
www.ntn-snr.com



With You



DOC_TRB_DISTRIB_CAT1.Da - Code SAP : 394.442 - Non contractual document - NTN-SNR Copyright International 04/2017 - Photos : Pedro Studio Photo.